

CATALOGUE

2021 EDITION



EXPERT IN ELECTRICAL
RISK PREVENTION

CATUTM

SICAME GROUP

DEAR CUSTOMERS,

By your side for over a century, we are pleased to present the new version of the CATU 2021 catalogue. This collection is dedicated to industry, residential, construction and services.

In Europe and in the rest of the world, new clearances allow a larger population to perform electrical and non-electrical work on or around installations and structures, in compliance with prevention rules. CATU is fully committed to supporting you to improve operator safety. Our constant actions to improve our solutions for protection and prevention against electrical risks are carried out in collaboration with our users and partners in France and all over the world. They guarantee our deep commitment and our security obligations towards all our customers.

Our expertise and our listening skills allow us to respond quickly to the needs related to the energy transition by offering solutions dedicated to the new market segments of electro-mobility, energy storage, renewable energies, and rail.

For a better reading comfort, you will discover in the following pages, a greater fluidity of presentation of the solutions. We have also added a new segmentation of PRO and EXPERT products as well as selection guides to assist you in your selection. Finally, highlighting FOCUS products and their benefits will make your choices easier.

Our Sales Department remains at your disposal (phone: +33 1 42 31 46 08 email: service.export@catuelec.com) for any request or information.

Thank you for your confidence in us!

CATU Team



S I N C E 1 9 1 9
100th
A N N I V E R S A R Y

Together for the past
100 years in the **prevention**
of **electrical risk**, and for
the **100 years to come!**

CATUTM
SICAME GROUP



IEC



Testing
accreditation n°1 - 0897
scope available on
www.cofrac.fr



ISO 9001 - OHSAS 18001
ISO 14001

CONTENT

	PPE – CPE		15
	LOCKING		67
	SIGNALLING		87
	DETECTION / MEASUREMENT		95
	LV EARTHING SYSTEMS		119
	LV LIVE WORKING TOOLS		129
	MV SUBSTATION EQUIPMENT		161
	MEDIUM VOLTAGE EQUIPMENT		183
	HV LINES AND SWITCHGEAR EQUIPMENT		199
	EARTHING CONNECTIONS		209
	ELECTRICIAN BAGS		217

GENERAL PRODUCTS INDEX



PPE - CPE

Eye protection.....	17
Head protection	18
Hand protection	23
Foot protection.....	28
Insulating mats.....	30
“Arc Flash” equipment.....	36
Work at height: harnesses and equipment.....	45
Work at height: insulating ladders	56
Work at height	61
Collective Protective Equipment – Cover-up Equipment.....	62



LOCKOUT TAGOUT

Safety padlocks	69
Padlock carriers and station.....	72
Multiple hasps	73
Circuit breaker lockout.....	75
Button cover	79
Valve lockouts.....	80
LoTo station and cabinets	82
Lockoutkits.....	84



SIGNALLING

Warning signs.....	88
Signalling and delineators.....	91



DETECTION / MEASUREMENT

Installation controllers.....	96
Phase rotation indicators	101
Low voltage detectors.....	102
Safety test probes and accessories	107
Medium voltage detectors.....	109
High voltage detectors	114
MV-HV Non-contact voltage detectors.....	116
Distance live-line alarm	116
Earthing connections	117



LV EARTHING SYSTEMS

Overhead bare	120
Overhead insulating.....	122
Earthing equipment for electric motors	123
LV cabinets	126



LV LIVE WORKING TOOLS

Insulated tools	130
Insulated tools kits.....	155
Insulated screwdrivers and jumpers accessories	158



MV SUBSTATION EQUIPMENT

Safety equipment.....	162
Substation equipment.....	163
Voltage detectors for MV substations	164
Voltage detectors for indoor and outdoor uses	165
Two-pole comparators and permanent indicator	167
IEC short-circuiting and earthing system for MV substation.....	170
Clamps for MV installations on bare conductors	173
Fixed points for permanent placement	174
Insulating sticks.....	175
VPIS and VDS systems for MV cubicles	177
Additional safety equipment.....	179
Life saving kits	181



MEDIUM VOLTAGE EQUIPMENT

IEC voltage detectors	184
Voltage detectors.....	185
Single phase comparators	186
IEC equipment	187
Insulating sticks.....	188
Clamp dispenser and accessories.....	191
Overhead line systems.....	192
Cables	193
Underground systems.....	195
Sticks accessories	196
Storage and maintenance products.....	197



HV LINES AND SWITCHGEAR EQUIPMENT

Voltage detectors.....	200
Insulating sticks.....	202
Clamps	203
Earthing system (APE).....	204
Earth clamps and cables.....	205
Cables and accessories	206
Accessories	207



EARTHING CONNECTIONS

Earth rods.....	210
Earthing connections	212



ELECTRICIAN BAGS

CHOOSE YOUR GLOVES SIZE

CHOOSE YOUR HARNESS SIZE

CHOOSE THE SIZE OF YOUR CAT'ARC CLOTHING!

LOW VOLTAGE DEAD WORKING GOLDEN RULES FOR A SAFE ELECTRICAL MAINTENANCE.....

GENERAL PRODUCTS INDEX

A djustable access points.....	206	E arth and continuity measurement device CATOHM™ DT-300.....	100	Headlamp for helmet.....	21
Aluminium cables.....	194	Earth clamp with security padlock.....	172	Hearing protection.....	22
Angled socket wrenches.....	146	Earth clamps.....	170/173/191	Helmets.....	19/20
Arc Flash and multi-risk CAT ^{ARC} garments.....	41	Earth clamps for overhead live networks and substations	205		
Arc Flash and multi-risk parka.....	39	Earth resistance tester.....	117/ 214		
Arc Flash face shield kit APC 2 - ATPV 12 cal/cm ²	37	Earth rod.....	191	I EC electronic voltage detector with probe, for indoor and outdoor uses.....	115/166
Arc Flash helmets.....	37	Earthing and short-circuiting device for bare conductors with security padlock.....	172	IEC electronic voltage detectors, "compact serie" for indoor and outdoor use.....	112/165/184/200
Arc Flash kits 25, 40, 65, 100 cal/cm ²	42	Earthing and short-circuiting device for fixed points....	170	IEC short-circuiting and earthing systems (three-phase crossarm networks).....	187
Arc Flash shield with head band.....	18	Earthing and short-circuiting equipment for engines and low voltage installations in the industry and the tertiary sector.....	123 to 125	IEC voltage detectors for outdoor use.....	114/201
Atex full body harness.....	46	Earthing connectors.....	212	Industrial single or multiphase plug lockout.....	78
Atex led headlamp for helmets.....	22	Earthing equipment.....	122	Infrared thermometer.....	97
		Earthing equipment for overhead lines systems.....	120	Installation on bare conductors.....	171
		Earthing system with interlocking clamps.....	204	Insulated cable cutter.....	181
B ags.....	218/222	Electrical adhesive tapes.....	66	Insulated knives.....	143
Backpack.....	220	Electrical and pneumatic plug lockouts.....	78	Insulated magnets for blankets.....	65
Bag for insulator cover.....	62	Electrical LoTo kit.....	85	Insulated helmets.....	19
Bags for insulating mat.....	34	Electrician helmets for work at height.....	19	Insulating adaptor.....	152
Bipolar voltage detector for direct voltage.....	113/168	Electrician helmets with integrated face shield.....	20	Insulating bent half round nose pliers.....	142
Blankets and clamps.....	66	End cutters.....	140	Insulating blanket.....	195
		Equipotential lines.....	206	Insulating boots.....	28
				Insulating caps.....	63
				Insulating flexible blankets.....	65/66
				Insulating flexible blankets of orange rubber.....	65
C able cutters.....	140	F ace shields.....	18	Insulating gloves.....	25
Cable spike equipment.....	195	Fixed length sticks.....	188	Insulating gloves for Arc Flash.....	38
Cable testing stick.....	195	Fixed points for permanent placement.....	174	Insulating ladders.....	56
Chain delineators.....	93	Flexible - type conductor cover.....	62	Insulating mats.....	32/33
Circuit breaker lockout.....	75	Full body harness.....	47	Insulating over shoes.....	28
Circuit breaker lockout kit.....	84	Fully insulated wire stripping pliers.....	141	Insulating platform.....	35
Clamp dispenser heads.....	191	Fuse puller.....	196	Insulating pliers.....	133/139
Clamps.....	203			Insulating rubber gloves.....	25
Clamps for installation on bare conductors.....	173	G as valve lockout.....	81	Insulating screwdrivers.....	131/137
Cleaning brushes.....	196	General lockout kit.....	84	Insulating slide ladders.....	57
Climbers for steel poles.....	55	Gloves.....	25	insulating sockets.....	148/150
Connection adaptors for insulating sticks.....	190	Glove box.....	26	Insulating stepladders.....	59
Connectors.....	212	Grounding flags.....	91	Insulating stick covers.....	176/189
Contact probes for L.V. tester.....	105	Group lock box.....	84	Insulating sticks for manoeuvring detectors & short- circuiting and earthing systems.....	202
Copper cables.....	193/205			Insulating sticks for substation.....	175/188
Copper/steel earth rods.....	211	H acksaws.....	144	Insulating universal pliers.....	142
		Hand stick.....	107	insulating wrenches.....	144/146
		Handling & cut resistant gloves.....	43	Insulation controller CATEX™ DT-500.....	98
		Harnesses.....	46/47	Insulator cover.....	62
		Hasps.....	73/74	Integrated voltage detecting system (V.D.S.).....	110/177
D ead blow mallet.....	154				
Detex™ 917-I and 918-I voltage detectors and testers...	104				
Diagonal cutters.....	140				
Digital clamp meter.....	96				
Discharge sticks.....	176				
Distance live-line alarm.....	116				

Integrated voltage presence indicating system (V.P.I.S)	110/177
Interface for integrated voltage detecting system (V.D.S) 178	
Intermediate elements with rain skirts	189
Intervention barrier	91
Intervention kit	155/163
Intervention kit for electricians	156

J umper cables	159
Jumper cables specially manufactured items	194

L adder stabilizing compensator	59
Lanyard	53
Life saving kits for M.V. substations.....	181
Lockout model for moulded units.....	77
LoTo station.....	83
Low voltage detectors	102
LV and MV insulating mats	32/33

M anoeuvring and rescue sticks.....	179
Manoeuvring hook.....	196
Mechanical and arc flash insulating gloves	25
Mittens	27
Mobile fall arrester kit	49/50
MS-917-L, MS-918-L and MS-920-EX	102 to 106
Multimeter.....	96
MV live working safety shoes against electrical hazards of step voltage.....	29

N omex III® undergloves.....	38
Non contact voltage detector.....	116

O perating testers	167
Overglasses.....	17
Overgloves	27

P adlocks	69/71
Padlocks cabinet	83
Permanent luminous indicator for indoor use	168
Phase indicator insulated screwdriver 1000 V.....	158
Phase rotation indicator DETEX MS-152 +	101
Phillips screwdrivers	136
Pliers kit	155

Plug pliers for pin terminals.....	139
Pneumatic glove tester	26
Pozidriv screwdrivers	136
Pozidriv screwdrivers with recessed blades	137
Pro electric full body harness	46

R atchets	154
Ratchet cable cutters	143
Recommended equipment for live working operations in low voltage compliant with the prescription of en 50110 standard.....	157

Rescue kit	48
Rescue sticks	179
Reversible ratchet ring wrenches	144
Rod tester.....	197
Rope blocker with lever stretcher.....	51
Rope operated clamp	207
Rotating gate valve lockouts.....	80
Round nose pliers.....	139

S afety adhesive tape	93
Safety boundary posts.....	92
Safety glasses	17
Safety lamps	179
Safety padlock.....	69 to 71
Safety shoes with insulating sole for indoor and dry environment.....	29
SCAN-ELEC: detects live ac wires and metallic parts	97
Scissors	154
Screwdrivers kit	155
Self adhesive warning signs.....	90
Separable voltage detecting system (V.D.S).....	178
Short circuiting device for LV cabinet.....	126
Short circuiting devices for LV industrial cabinets.....	127
Short-circuiting and earthing system carrying bags	207
Short-circuiting and earthing systems.....	192
Short-circuiting and earthing systems nevers ENEDIS type	121
Short-circuiting systems	120
Short-circuiting systems	122
Shunt telescopic probes	158
Signalling tape	93
Single pole phase comparator for indoor and outdoor use.....	186
Sockets set 1/2" (12.7 mm)	153
Sockets set 3/8" (9.53 mm)	153
Sound phase comparator	177

Spool with earthing connection	191
Stackable ladder elements	61
Stainless steel earth rods	211
Standard extension ladders	58
Standard sticks	175
Static discharge stick	176
Stick with skirt	175
Storage bag.....	108
Storage tube for insulating mat.....	34
Strap for insulating mat.....	34
Stripping tool for lv cables.....	141
Stripping tools for lv cables	142
Substation signs.....	89

T ag-out badges.....	77
Telescopic measuring sticks.....	61
Tether rope with tension device.....	52
Textile tape delineators.....	94
Threaded adapters	127/158
Tools bags	219

U ndergloves	27
Universal button cover.....	79
Universal pliers.....	138

V oltage detector for capacitive terminals of elbow MV connector	109/164
Voltage detector for m.v. substation (indoor use) ..	109/164
Voltage detectors LV	102
Voltage detectors MV	109
Voltage detectors HV	114
Voltage tester for M.V. separable connectors 10-36 kV	178

W all mounted support for sticks.....	180/189
Wall station for padlocks	73
Warning flags.....	91
Warning signs	88
Wheeled backpack	220
Wire gun tester.....	208
Wire stripping pliers	141
Work gloves	43



GENERAL REFERENCE INDEX

References	Pages	References	Pages	References	Pages	References	Pages
A2C-10-Z*	211	AL-240-BL-00-EX	69	ALP-4/3	73	AT-58/05	90
A2C-15-Z*	211	AL-240-BL-111-EX	69	ALP-4/6	73	AT-58/1	90
A3MC-10-Z*	211	AL-240-BL-Z-EX	69	ALPV-L-D	81	AT-59/05	90
A3MC-15-Z*	211	AL-240-J-00-EX	69	AM-20-GB	89	AT-59/1	90
AC-10-Y	211	AL-240-J-111-EX	69	AM-20-RM	89	AT-60/05	90
AC-15-Y	211	AL-240-J-Z-EX	69	AM-282/2-RM	89	AT-60/1	90
AC-21	89	AL-240-S-(**)-EX	69	AM-32/3	89	AT-61/05	90
AC-44	89	AL-240-S-00-EX	69	AM-33/3	89	AT-61/1	90
AD-01	89	AL-240-S-B-00-EX	69	AM-34/2	89	AT-62/05	90
AFG-1001-*	41	AL-240-S-B-111-EX	69	AM-344	88	AT-62/1	90
AFG-2000-*	41	AL-240-S-BL-00-EX	69	AM-344-GB	88	AT-63/05	90
AFG-2001-*	41	AL-240-S-BL-111-EX	69	AM-344/05	88	AT-63/1	90
AFG-2300-*	39	AL-240-S-J-00-EX	69	AM-345-GB	88	AT-67/05	90
AFG-BELT-**	41	AL-240-S-J-111-EX	69	AM-41/1	88	AT-67/1	90
AL-127	94	AL-240-S-V-00-EX	69	AM-41/2	88	AT-68/05	90
AL-129	94	AL-240-S-V-111-EX	69	AM-467-GB	77	AT-68/1	90
AL-138	93	AL-240-S-Z-EX	69	AM-467-GB	88	BCY	212
AL-139	93	AL-240-V-00-EX	69	AM-49/1	88	C-92-20	167
AL-140	93	AL-240-V-111-EX	69	AM-49/2	88	C-92-492	185
AL-145R/200	75	AL-240-V-Z-EX	69	AM-51/1	88	C2C-10-Z (1)	211
AL-200	74	AL-240-Z-EX	69	AM-61-GB	89	C2C-15-Z (1)	211
AL-201-C/1	75	AL-260-(**)-EX	69	AM-61-RM	89	C2C95Z	212
AL-201/1	75	AL-260-00-EX	69	AMI-10	211	CC -260-132/380 (*)	115
AL-202	74	AL-260-S-(**)-EX	69	AMI-15	211	CC -260-132/380 (*)	201
AL-203*	74	AL-260-S-00-EX	69	AP-460	88	CC-10-Y	211
AL-204	77	AL-260-S-Z-EX	69	AP-460*	77	CC-127-ENEDIS-C	121
AL-205	76	AL-260-Z-EX	69	AP-499/1	77	CC-15-Y	211
AL-205/5	76	AL-31	93	AP-499/1	88	CC-161-K	178
AL-206	72	AL-31/05	93	AP-510-BT-GB	88	CC-161-K*	109
AL-207/30	72	AL-31/25	93	AP-510-GB	88	CC-161-K*	164
AL-208-C *	76	AL-316*	92	AP-510-GB	89	CC-162-K*	109
AL-208-D **	76	AL-318**	92	AP-951/2	89	CC-162-K*	164
AL-209-L	77	AL-32/05	93	AT-41/025	90	CC-20-Y	211
AL-210	76	AL-32/25	93	AT-41/05	90	CC-260-150/420 (*)	115/201
AL-211/1	79	AL-321*	92	AT-41/1 **	90	CC-260-225/550 (*)	115/201
AL-211/2	79	AL-322**	92	AT-49/025	90	CC-260-60/235 (*)	115/201
AL-212	72	AL-323*	92	AT-49/05 **	90	CC-265-120/245 (*)	115/201
AL-214	79	AL-324**	92	AT-49/1 **	90	CC-265-225/420 (*)	115/201
AL-216	75	AL-325	91	AT-50/025	90	CC-265-44/132 (*)	115/201
AL-220	75	AL-326	91	AT-50/053	90	CC-265-60/150 (*)	115/201
AL-230-(**)-EX	69	AL-53	91	AT-50/1	90	CC-265-60/90 (*)	115/201
AL-230-S-(**)-EX	69	AL-58	91	AT-5005	93	CC-265-90/225 (*)	115/201
AL-230-S-Z-EX	69	AL-60	91	AT-51/025	90	CC-365-10/30-(*)	185
AL-230-Z-EX	69	AL-62-A	94	AT-51/05	90	CC-365-101	185
AL-236-00-EX*	72	AL-63-A	94	AT-51/1	90	CC-365-3/10-(*)	185
AL-236-111-EX	72	AL-65-A	94	AT-52/05	90	CC-765- 5,5/20-(*)	112
AL-236-222-EX	72	ALED3	116	AT-52/1	90	CC-765- 5,5/20-(*)	165
AL-236-S-00-EX*	72	ALM-20/45	74	AT-53/05	90	CC-765- 5,5/20-(*)	184
AL-236-S-111-EX	72	ALM-6/25	74	AT-53/1	90	CC-765- 5,5/20-(*)	200
AL-236-S-222-EX	72	ALM-6/38	74	AT-54/05	90	CC-765-10/30-(*)	112
AL-240-(**)-EX	69	ALM-6/8	74	AT-54/1	90	CC-765-10/30-(*)	165
AL-240-00-EX	69	ALP-03	73	AT-55/05	90	CC-765-10/30-(*)	184
AL-240-B-00-EX	69	ALP-06	73	AT-55/1	90	CC-765-10/30-(*)	200
AL-240-B-111-EX	69	ALP-12/2M	73	AT-56/05	90	CC-765-10/36-(*)	112
AL-240-B-Z-EX	69	ALP-12/5M	73	AT-56/1	90	CC-765-10/36-(*)	165



References	Pages
CC-765-10/36-(*)	184
CC-765-10/36-(*)	200
CC-765-11/33-(*)	112
CC-765-11/33-(*)	165
CC-765-11/33-(*)	184
CC-765-11/33-(*)	200
CC-765-15/45-(*)	112
CC-765-15/45-(*)	165
CC-765-15/45-(*)	184
CC-765-15/45-(*)	200
CC-765-2/72-(*)	112
CC-765-2/72-(*)	165
CC-765-2/72-(*)	184
CC-765-2/72-(*)	200
CC-765-20/66-(*)	112
CC-765-20/66-(*)	165
CC-765-20/66-(*)	184
CC-765-20/66-(*)	200
CC-765-3/10-(*)	112
CC-765-3/10-(*)	165
CC-765-3/10-(*)	184
CC-765-3/10-(*)	200
CC-765-30/66-(*)	112
CC-765-30/66-(*)	165
CC-765-30/66-(*)	184
CC-765-30/66-(*)	200
CC-765-44/132-(*) (1)	112
CC-765-44/132-(*) (1)	165
CC-765-44/132-(*) (1)	184
CC-765-44/132-(*) (1)	200
CC-765-5/18-(*)	112
CC-765-5/18-(*)	165
CC-765-5/18-(*)	184
CC-765-5/18-(*)	200
CC-765-63/90-(*) (1)	112
CC-765-63/90-(*) (1)	165
CC-765-63/90-(*) (1)	184
CC-765-63/90-(*) (1)	200
CC-775-11/22-33/66-K	112
CC-775-11/22-33/66-K	165
CC-775-11/22-33/66-K	184
CC-775-11/22-33/66-K	200
CC-775-12/24-52/132-(*)	112/165/184/200
CC-775-2/7-12/25-(*)	112/165/184/200
CC-775-2/72-34/115-(*)	112/165/184/200
CC-775-2/72:12/36-(*)	112/165/184/200
CC-775-33/11:22/66-K	112/165/184/200
CC-775-4/14-24/69-K	112/165/184/200
CC-775-4/144-25/69-K	112/165/184/200
CC-775-47/15-25/69-K	112/165/184/200
CC-775-6/12-22/66-C	112/165/184/200
CC-965-10/30	115/166
CC-965-10/30-C	115/166
CC-965-10/30-K	115/166
CC-965-5/15	115/166

References	Pages
CC-965-5/15-C	115/166
CD-124	179
CD-128	179
CE-4-21-(*)	175
CE-4-21-(*)	188
CE-4-30-(*)	175
CE-4-30-(*)	188
CE-5-105-X	175
CE-5-105-X	188
CE-5-50-X	175
CE-5-50-X	188
CE-5-60-X	175
CE-5-60-X	188
CE-5-70-X	175
CE-5-70-X	188
CE-5-90-X	175
CE-5-90-X	188
CE-75-(**)	175
CE-75-(**)	188
CF-3-72...-(*)	175
CF-3-72...-(*)	176
CF-5-110-(*)	188
CF-5-170-(*)	188
CF-5-90-(*)	175
CF-5-90-(*)	188
CG-0-(*)-R-28	25
CG-00-(*)-R-28	25
CG-05-(*)	25
CG-1-(*)-NR	25
CG-10-(*)	25
CG-117	26
CG-2-(**)-NR	25
CG-3-(**)-NR	25
CG-35/2 *	26
CG-36-1	26
CG-36-2	26
CG-37	38
CG-4-(***)-NR	25
CG-80-(*)	27
CG-81	27
CG-951-(*)	43
CG-952-(*)	43
CG-96-(*)	43
CG-97-xx	43
CG-981-(*)	27
CG-991-(*)	27
CGM-0-(*)	25
CGM-00-(*)	25
CGM-1-(*)	25
CGM-2-(**)	25
CGM-3-(**)	25
CGM-4-(*)-ARC-40	25
CGM-4-(*)-ARC-40	38
CGM-4-(***)	25
CI-06-D	171/180/189

References	Pages
CI-08	180/189
CI-10-D	180/189
CI-12-D	180/189
CI-15-D	176/180/189
CI-18-D	180/189
CI-70	180
CL 6-100-30000**	113/168
CL 6-120-5000 *	113/168
CL-1-06	167
CL-40010	168
CL-465-10-36-C	109
CL-465-10-36-M	109
CL-465-10/30-2 **	109/164
CL-465-10/30-M *	109/164
CL-495-3	110/177
CL-497-00	110/177
CL-498-00*	178
CL-499/101	178
CL-7-06/18-(*)	186
CL-7-10/30-(*)	186
CL-7-10/30-1-(*)	186
CL-7-12/36-(*)	186
CL-8-05	167
CL-8-36	167
CL-8-36/1 *	167
CM-02-(*)	196
CM-03-K	196
CM-04-K	196
CM-1-10	115/166/176/189
CM-1-15	176/189
CM-1-20	176/189
CM-3-03	176/189
CM-3-04	176/189
CM-3-05	176/189
CM-3-06	176/189
CM-3900-J	202
CM-4115-(*)	202
CM-4120-(*)	202
CM-4125-(*)	202
CM-4130-(*)	202
CM-4220-(*)	202
CM-4230-(*)	202
CM-4240-(*)	202
CM-4345-(*)	202
CM-4360-(*)	202
CM-4400-J	189
CM-45	179
CM-4610	202
CM-4610-(*)	202
CM-4610-I	202
CM-4615	202
CM-4615-I	202
CM-4620	202
CM-4620-I	202
CM-4625	202

References	Pages
CM-4625-I	202
CM-50	176
CM-7-10-A	175/188
CN-7-003-012-K	116
CN-7-005-036-K	116
CN-7-010-036-K	116
CN-7-011-066-K	116
CN-7-066-410-K	116
CN-7-220-500-K	116
CN-7-315-765-K	116
COL-32/100	212
COL-8/32	212
CS-01-C	180
CS-225*	179
CS-45*	179
CS-45/2**	179
CS-90*	179
CT-7-25/1	35
CT-7-40/1	35
CT-7-63	35
CT-701	35
CT-9-25	35
CT-9-45	35
CT-9-63	35
CZ-53-MR	182
CZ-53-MR/2	182
CZ-53-R	182
CZ-53-R/2	182
CZ-54	181
CZ-54-FM	181
CZ-55	181
CZ-55-FM	181
CZ-60	181
DT-300*	100
DT-500 *	98
GL-100	81
GL-101	81
HL-100	80
HL-101	80
HL-102	80
HL-103	80
HL-104	80
HL-105	80
HL-200	80
HL-201	80
HL-202	80
HL-203	81
KIT-01	163
KIT-02	163
KIT-03	155
KIT-04	155
KIT-05	155
KIT-07	155
KIT-10	163
KIT-23	135

GENERAL REFERENCE INDEX

References	Pages	References	Pages	References	Pages	References	Pages
KIT-24	135	M-881602	98	MC-184-6M	127/158	MO-187	37
KIT-25	135	M-881836	19/21	MC-185-10F	127/158	MO-23	55
KIT-27	135	M-881837	21	MC-185-10M	127/158	MO-284	18
KIT-ARC-100-B-(*)	42	M-881838	21	MC-281	123	MO-284-C	18
KIT-ARC-25-B-(*)	42	M-882671	21	MC-281/1	124	MO-286	18
KIT-ARC-40-B-(*)	42	M-882677	21	MC-281/870	125	MO-32/3	49
KIT-ARC-65-B-(*)	42	M-883209	18	MC-281/870	125	MO-34	219
KIT-ARC-A-01-C***	41	M-883210	18	MC-2811/870	125	MO-36	219
KIT-ARC-A-01-JP***	41	M-883295	18	MC-2811/870	125	MO-38510	157
KIT-ARC-A-02-C***	41	M-883298	18	MC-296-A	126	MO-42/1	218
KIT-ARC-A-02-JP***	41	M-883374	39	MC-296-B	126	MO-42/2	218
KIT-CONSI-01E	85	M-883377	39	MC-296-C	126	MO-43	218
KIT-CONSI-01G-GB	84	M-883378	39	MC-296-NFC-16	127	MO-44	220
KIT-CONSI01D-GB	84	M-883379	39	MC-296-NFC-25	127	MO-50	219
KIT-HAUT-05	47	M-883380	39	MC-296-NFC-35	127	MO-510-03 *	157
KIT-MD04-R	48	M-883381	39	MD-02	54	MO-510-03/2 *	157
M-24-120	193	M-92-28	196	MD-03	54	MO-52020	52
M-24-120-S	193	M-921647	100	MD-10-C	196	MO-52021	52
M-24-150	193	M-95-236	61	MD-12-C	196	MO-54	55
M-24-150-S	193	M-951143	107	MD-14-C	196	MO-54010	53
M-24-16	193	M-951981	98	MD-40-B	196	MO-54020	52
M-24-16-S	193	M-952270	121	MD-42-B	196	MO-56009	52
M-24-25	193	M-952271	100/108	MF-60	208	MO-563-A(*)	46
M-24-25-S	193	M-952325	102	MF-61	208	MO-591000	50
M-24-35	193	M-952325	106	MF-62	208	MO-591002	51
M-24-35-S	193	M-952439	107	MF-63	208	MO-592002	51
M-24-35-V	206	M-952567	121	MF-66	208	MO-61	51
M-24-40-S	193	M-952568	121	MK-A15-PPM638	71	MO-61001	143
M-24-50	193	M-9573	170	MO-052	53	MO-61002	143
M-24-50-S	193	MO-37	218	MO-053	53	MO-64501	144
M-24-70	193	MO-38	220	MO-103	218	MO-64502*	144
M-24-70-S	193	MO-39	219	MO-11000	17	MO-650-D	136
M-24-95	193	MC-126	158	MO-11001	17	MO-652-D	136
M-24-95-S	193	MC-126/1	158	MO-11010	17	MO-65200D	137
M-28-120	194/206	MC-142	159	MO-151	22	MO-65202	136
M-28-150	194/206	MC-143	159	MO-151/100	22	MO-65202D	137
M-28-50	194	MC-145	159	MO-152	22	MO-65203	136
M-28-70	194/206	MC-146	159	MO-155	19	MO-65203D	137
M-611386	121	MC-153/05	159	MO-160	34	MO-65204	136
M-762118	102	MC-153/10	159	MO-161	34	MO-65204D	137
M-78723	115/166	MC-153/30	159	MO-180-ARC-12	37	MO-65205	136
M-86484	26	MC-153/60	159	MO-180-ARC-4	37	MO-652055D	137
M-87-153	207	MC-155/05	159	MO-180-ARC12 VISOR	37	MO-65205D	137
M-87-53	207	MC-155/10	159	MO-180-ARC4 VISOR	37	MO-65206	136
M-87285	102/106/108	MC-155/20	159	MO-182/1-B	19/37	MO-65206D	137
M-87290	108	MC-155/30	159	MO-182/1-J	19	MO-65207	136
M-87292	98/108	MC-155/60	159	MO-182/1-R	19	MO-652082D	137
M-87295	207/219	MC-155/80	159	MO-183-BL	19	MO-65208D	137
M-87303	219	MC-181	127/158	MO-183-RL	19	MO-65209	136
M-87370	218	MC-182	127/158	MO-185-B	20	MO-652102D	137
M-87384	21/37	MC-182-8M	127/158	MO-185-BL	20	MO-65210D	137
m-87386	219	MC-183	127/158	MO-185-BLM	20	MO-65211	136
m-87387	219	MC-184-6F	127	MO-185-J	20	MO-65212D	137
M-881601	98	MC-184-6F	158	MO-185-R	20	MO-65222	158



References	Pages
MO-65230	136
MO-65232	136
MO-652321D	137
MO-65232D	137
MO-65233D	137
MO-65234	136
MO-65234D	137
MO-65236	136
MO-65236D	137
MO-65238	136
MO-65238D	137
MO-65240	136
MO-652405D	137
MO-652406D	137
MO-652410D	137
MO-65242	136
MO-65244	136
MO-652441D	137
MO-65244D	137
MO-65245D	137
MO-65246	136
MO-65246D	137
MO-65248	136
MO-65248D	137
MO-653-D	136
MO-65405	138
MO-65406	138
MO-65505	138
MO-65506	138
MO-66000C	142
MO-66001	138
MO-66002	138
MO-66003	138
MO-66005	138
MO-66102	139
MO-66105	139
MO-66202	139
MO-66300	138
MO-66301	138
MO-66302	138
MO-66303C	142
MO-66402	139
MO-66404	139
MO-66404CC	143
MO-66500	140
MO-66505*	140
MO-67101	140/142
MO-67102	140
MO-67103	140
MO-67302	141
MO-67302C	141
MO-67305	142
MO-67306	142
MO-67401	140

References	Pages
MO-67402	140
MO-67404	140
MO-67500	141
MO-67501	141
MO-67502	141
MO-67599	143
MO-67600	143
MO-67601	143
MO-67611	143
MO-67700	141
MO-67701	141
MO-68/10	49
MO-68/15	49
MO-68006	145
MO-68007	145
MO-68008	145
MO-68008/19	145
MO-68009	145
MO-68010	145
MO-68011	145
MO-68012	145
MO-68013	145
MO-68014	145
MO-68015	145
MO-68016	145
MO-68017	145
MO-68018	145
MO-68019	145
MO-68020	145
MO-68021	145
MO-68022	145
MO-68023	145
MO-68024	145
MO-68025	145
MO-68026	145
MO-68027	145
MO-68028	145
MO-68029	145
MO-68030	145
MO-68032	145
MO-68106	146
MO-68107	146
MO-68108	146
MO-68109	146
MO-68110	146
MO-68111	146
MO-68112	146
MO-68113	146
MO-68114	146
MO-68115	146
MO-68116	146
MO-68117	146
MO-68118	146
MO-68119	146

References	Pages
MO-68120	146
MO-68121	146
MO-68122	146
MO-68123	146
MO-68124	146
MO-68125	146
MO-68126	146
MO-68127	146
MO-68128	146
MO-68129	146
MO-68130	146
MO-68132	146
MO-68205	146
MO-68206	146
MO-68207	146
MO-68208	146
MO-68209	146
MO-682101	146
MO-682111	146
MO-682121	146
MO-682131	146
MO-682141	146
MO-682151	146
MO-682161	146
MO-682171	146
MO-682181	146
MO-682191	146
MO-682211	146
MO-682231	146
MO-68224	146
MO-68226	146
MO-68227	146
MO-68228	146
MO-68229	146
MO-68230	146
MO-68232	146
MO-68310	147
MO-68311	147
MO-68312	147
MO-68313	147
MO-68314	147
MO-68316	147
MO-68317	147
MO-68319	147
MO-68321	147
MO-68322	147
MO-68402	132
MO-68403	132
MO-68404	132
MO-68405	132
MO-68406	132
MO-68408	132
MO-68610	147
MO-68613	147

References	Pages
MO-68614	147
MO-68620	147
MO-68621	147
MO-68701	145
MO-68702	145
MO-68703	145
MO-68704	145
MO-68705	145
MO-68713	147
MO-68714	147
MO-68717	147
MO-68719	147
MO-68721	147
MO-69/10	50
MO-69/15	50
MO-69/20	50
MO-69002	144
MO-69003	144
MO-69004	144
MO-69005	144
MO-69025	154
MO-69050	154
MO-69051	154
MO-69054	154
MO-690541	154
MO-69060*	154
MO-69210	144
MO-69213	144
MO-69216	144
MO-69217	144
MO-69218	144
MO-69219	144
MO-69306	148
MO-69307	148
MO-69308	148
MO-69308/23	153
MO-69309	148
MO-69310	148
MO-693100	148
MO-69311	148
MO-69312	148
MO-69313	148
MO-69314	148
MO-69315	148
MO-69316	148
MO-69317	148
MO-69318	148
MO-69319	148
MO-69321	148
MO-69322	148
MO-69393	148
MO-69394	148
MO-69395	148
MO-69396	148

GENERAL REFERENCE INDEX

References	Pages	References	Pages	References	Pages	References	Pages
MO-69397	148	MO-69613	147	MO-72036	131	MP-120/03-2	33
MO-69398	148	MO-69614	147	MO-72038	131	MP-120/03-5	33
MO-69408	150	MO-69615	147	MO-72040	131	MP-120/03-10	33
MO-69408/23	153	MO-69616	147	MO-72042	131	MP-120/05-0	33
MO-69409	150	MO-69617	147	MO-72044	131	MP-120/05-1	33
MO-69410	150	MO-69618	147	MO-72046	131	MP-120/05-2	33
MO-69411	150	MO-69619	147	MO-72048	131	MP-120/05-5	33
MO-69412	150	MO-69621	147	MO-720510	132	MP-120/05-10	33
MO-69413	150	MO-69622	147	MO-720515	132	MP-120/20-5	33
MO-69414	150	MO-69623*	147	MO-720520	132	MP-120/20-10	33
MO-69415	150	MO-69624	147	MO-720525	132	MP-123	66
MO-69416	150	MO-69804	149	MO-720527	132	MP-123/1	66
MO-69417	150	MO-69805	149	MO-720530	132	MP-123/2	66
MO-69418	150	MO-698055	149	MO-720540	132	MP-18-LOT	66
MO-69419	150	MO-69806	149	MO-720545	132	MP-19/LOT	66
MO-69420	150	MO-69807	149	MO-720550	132	MP-20	34
MO-69421	150	MO-69808	149	MO-72056	132	MP-20/11	33
MO-69422	150	MO-69809	149	MO-72057	132	MP-20/16	33
MO-69423	150	MO-69810	149	MO-72058	132	MP-20/21	33
MO-69424	150	MO-69811	149	MO-72059	132	MP-20/22	33
MO-69425	150	MO-69812	149	MO-72100E	154	MP-20/26	33
MO-69426	150	MO-69813	149	MO-72102	133	MP-20/66	33
MO-69427	150	MO-69814	149	MO-72122	134	MP-211	195
MO-69428	150	MO-698M03	149	MO-72132	133	MP-212	195
MO-69429	150	MO-698M04	149	MO-72142	133	MP-213 *	195
MO-69430	150	MO-698M05	149	MO-72155	134	MP-213/EXT	195
MO-69432	150	MO-698M06	149	MO-72162	134	MP-213/LAM	195
MO-694M04	150	MO-698M07	149	MO-72172	133	MP-22	62
MO-694M05	150	MO-698M08	149	MO-72200	132	MP-220	64
MO-694M06	150	MO-69903	145	MO-745-D	154	MP-220/1	64
MO-694M08	150	MO-69904	145	MO-831	61	MP-23	62
MO-694M10	150	MO-69905	145	MO-832	61	MP-31	62
MO-694M12	150	MO-69906	145	MO-883208	21	MP-32/10	62
MO-694M14	150	MO-69908	145	MP 700-100	60	MP-32/15	62
MO-694M17	150	MO-69910	145	MP 700-200	60	MP-33	62
MO-694M19	150	MO-69912	145	MP-01	34	MP-35	64
MO-69512	154	MO-69T15	148	MP-02	34	MP-35/12	64
MO-69513*	154	MO-69T20	148	MP-100/02-5	32	MP-37	64
MO-69514*	154	MO-69T25	148	MP-100/02-10	32	MP-40	64
MO-69522	149	MO-69T30	148	MP-100/03-5	33	MP-400	61
MO-69522-V	152	MO-69T40	148	MP-100/03-10	33	MP-400-2	61
MO-69523	148	MO-69T45	148	MP-100/05-1	33	MP-402-MB	61
MO-69524	150	MO-69T50	148	MP-100/05-10	33	MP-402-MI	61
MO-69533	148	MO-71	47	MP-100/05-5	33	MP-403-MB	61
MO-69534	150	MO-72-ATEX	46	MP-100/20-5	33	MP-403-MI	61
MO-69535	152	MO-72002	131	MP-100/20-10	33	MP-4110	66
MO-69536	152	MO-72003	131	MP-11/11	32	MP-41530	66
MO-69537	152	MO-72004	131	MP-11/16	32	MP-41A70/4	64
MO-69539	152	MO-72005	131	MP-11/21	32	MP-42/11	33
MO-69540	149	MO-72006	131	MP-11/22	32	MP-42/16	33
MO-69608	147	MO-72008	131	MP-11/26	32	MP-42/26	33
MO-69609	147	MO-72010	131	MP-11/66	32	MP-42/66	33
MO-69610	147	MO-72030	131	MP-120/02-5	32	MP-46500	59
MO-69611	147	MO-72032	131	MP-120/02-10	32	MP-46501	59
MO-69612	147	MO-72034	131	MP-120/03-1	33	MP-50	62



References	Pages
MP-501-D	61
MP-502-D	61
MP-503-D	61
MP-506/2	57
MP-508/2	57
MP-509/2	57
MP-510/2	57
MP-514/2	57
MP-515/2R	57
MP-59	62
MP-60/02-10	32
MP-60/02-5	32
MP-60/03-5	33
MP-60/03-10	33
MP-60/05-1	33
MP-60/05-5	33
MP-60/05-10	33
MP-60/20-5	33
MP-60/20-10	33
MP-602-D	56
MP-603-D	56
MP-604-D	56
MP-605-D	56
MP-607/2-I	58
MP-607/3-I	58
MP-608/2-I	58
MP-608/3-I	58
MP-609/2-I	58
MP-624/2-D	56
MP-625-D	66
MP-627-D	66
MP-634/2-D	56
MP-635/10-D	63
MP-635/15-D	63
MP-635/20-D	63
MP-635/25-D	63
MP-635/30-D	63
MP-635/40-D	63
MP-635/50-D	63
MP-635/60-D	63
MP-700-1	59
MP-700-2	59
MP-700-3	59
MP-700-4	59
MP-700-5	59
MP-700-I1	60
MP-700-I2	60
MP-700-I3	60
MS-124/2	21
MS-126	22
MS-152 +	101
MS-415	107
MS-415-P	107
MS-415-P5	107
MS-62	108

References	Pages
MS-63	108
MS-8013	105
MS-8014	105
MS-917-L	104
MS-918-L	102
MS-920-EX	106
MT-1910-EP	170
MT-1910/870	172
MT-1911	170
MT-1911-E	170
MT-1920-EP	170
MT-1920/1EP	170
MT-1921	170
MT-1921-E	170
MT-1951/10	174
MT-1951/12	174
MT-205	122
MT-206	122
MT-207	122
MT-222	122
MT-223	122
MT-242	120
MT-244	120
MT-245	120
MT-249	120
MT-2950/35	174
MT-2951	174
MT-2951/1	174
MT-2951/2	174
MT-3950/35	174
MT-3951	174
MT-3951/1	174
MT-3952	174
MT-3952/1	174
MT-40	194
MT-404	120
MT-405	120
MT-406	120
MT-407	120
MT-508/36	192
MT-508/46	192
MT-509/3	121
MT-509/3EP	121
MT-509/3VAT	121
MT-546	121
MT-5805	171
MT-5805/870	172
MT-615/1-7.5	122
MT-615/2-7.5	122
MT-630-C	191
MT-630-K	191
MT-630-S	191
MT-633-C	191
MT-633-K	191
MT-633-S	191

References	Pages
MT-634-C/K	191
MT-634/1-C/K	191
MT-635/1-C/K/S	191
MT-640-S	191
MT-641-S	191
MT-650	122/191
MT-6613	187
MT-6613 *	187
MT-6613/1	187
MT-6613/1 **	187
MT-70/1	194
MT-701/1	207
MT-731-(*)	203
MT-732-(*)	203
MT-734-(**)	203
MT-735-(*)	203
MT-735-P4	206
MT-737-H	203
MT-790	206
MT-792	206
MT-797	206
MT-812-C	173
MT-814/2	173
MT-814/3	173
MT-815-1/C	173
MT-815-C	173
MT-815-E	173
MT-815-S	173
MT-834-E	204
MT-834-H	204
MT-834-T	204
MT-835-E	204
MT-835-H	204
MT-835-T	204
MT-837-E	204
MT-837-H	204
MT-837-T	204
MT-840/1	173/191
MT-8408	171
MT-841	173
MT-843	191
MT-843	205
MT-843-P	205
MT-847	205
MT-852	205
MT-853	205
MT-870	172
MT-890	171
MT-891	171
MT-893	171
MT-895	171
MT-920-E	174
MT-925-E	174
MT-934	204
MT-935	204

References	Pages
MT-951/1	174
MT-951/2	174
MT-951/3	174
MT-952/1	174
MT-952/2	174
MT-952/3	174
MT-953/08	174
MT-953/12	174
MT-955/08	174
MT-955/12	174
MT-956	174
MT-9801	171
MV-137-(*)	28
MV-138-(*)	28
MV-139-(*)	28
MV-222-*	29
MV-223-*	29
MV-226-*	29
MV-227-*	29
MV-232/1-*	29
MX-215	197
MX-404 *	110/177
MX-430-M	214
MX-430-M	117
MX-433-T	118/214
MX-701 *	96
MX-702 *	96
MX-704 *	97
MX-710	97
PL-100	78
PL-101	78
PL-102	78
PL-103	78
PP-4-38-B-Z	71
PP-4-38-BK-Z	71
PP-4-38-G-Z	71
PP-4-38-R-*	71
PP-4-38-R-Z	71
PP-4-38-W-Z	71
PP-4-38-Y-Z	71
PP-6-38-R-*	71
PP-6-38-R-Z	71
RL-100	73
SL-101	83
SL-102	83
SL-103-04-01-Y	83
SL-106	83
SO-10	51
TO-2-16	212
TO-2-19	212
TO-3-16/19	212
ZEMCC-2851-H	173



The new website www.catuelec.com is online!

FOLLOW

CATU™ NEWS

- Responsive site, which adapts to all screen sizes (smartphone, tablet, computer)
- Improved and structured design with complete content on solutions:
 - technical sheet,
 - videos,
 - leaflets,
 - user manual,
 - authorization for use,
 - associated products,
 - commercial documentation
- Highlighting news and the latest CATU innovations



FOLLOW US AS WELL ON YOUTUBE
AND SUSCRIBE TO OUR CHANNEL.

NUMEROUS VIDEOS ON CATU'S
SOLUTIONS IN ELECTRICAL SAFETY !

AVAILABLE IN DIFFERENT LANGUAGES.



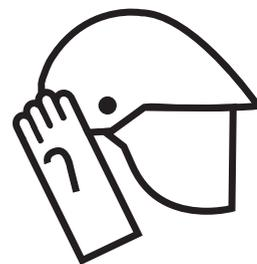

PPE - CPE

EYE PROTECTION	17
HEAD PROTECTION	18
HAND PROTECTION	23
FOOT PROTECTION	28
INSULATING MATS	30
“ARC FLASH” EQUIPMENT	36
WORK AT HEIGHT: HARNESSES AND EQUIPMENT	45
WORK AT HEIGHT: INSULATING LADDERS	56
WORK AT HEIGHT	61
COLLECTIVE PROTECTIVE EQUIPMENT – COVER-UP EQUIPMENT	62



PPE - CPE

KEY ADVANTAGES IN RISK PREVENTION

PPE: PERSONAL PROTECTIVE EQUIPMENT

PPE are defined as any equipment designed and manufactured to be worn or held by a person for protection against one or more risks to that person's health or safety.



CPE: COLLECTIVE PROTECTIVE EQUIPMENT

Collective protective equipment for preventing from electrical hazards. Comprises the products that close off the hazard means of :

- Distance (marking, signs),
- Obstacles (covers, screen, barrier),
- Insulation (insulating blankets, insulating caps, etc.).

CPE must comply with the current standards.



PPE CHECK

- Every PPE must be verified at least visually before and after every use.
- Periodic tests must be made by qualified persons and at least annually.
- If the slightest doubt exists the equipment must be discarded and replaced by a new one.

SYMBOL EXPLANATION

-  - Label with a double triangle symbol IEC 60 417-5216, suitable for work on live wires.
-  - Label with a mechanical hammer symbol, suitable for gloves with additional mechanical properties.

THE RESPONSIBILITY OF THE EMPLOYER

- To give free of charge and in a personal way equipment necessary and adapted to the risks,
- To watch over their actual use,
- To ensure the necessary replacement as well as the maintenance and the compliance,
- To inform the users on the risks they are protected against.

REGULATIONS

The Regulation (EU) 2016/425 of the Council of 9 March 2016 on personal protective equipment and repealing Council Directive 89/686/EEC, ensures common standards for personal protective equipment (PPE) in all Member States in terms of protection of health and the safety of users, while enabling the free movement of PPE within the Union.



SAFETY GLASSES

Protection against the UV radiation and the impact of high-speed solid particles.

CAUTION: DO NOT USE FOR WELDING OPERATIONS.

Reference	Characteristics	Anti UV	Resistance
MO-11000	Clear lenses	99.5 % < 370 nm	Level F Impact: 6 mm steel ball launched at 45 m/s
MO-11001	Tinted lenses	99.5 % < 370 nm	

BENEFITS

- "Soft-flex" ear pieces guaranteeing low pressure fit.
- Polycarbonate lense with a large field of vision. Anti-scratch, anti-impact and anti-chemical product treatments.



MO-11000



MO-11001



EN 166 / EN 170



OVERGLASSES

Polycarbonate overglasses. Protection against the UV radiation and the impact of high-speed solid particles.

CAUTION: DO NOT USE FOR WELDING OPERATIONS.

Reference	Characteristics	Anti UV	Resistance
MO-11010	Clear lenses	100% 180 < 400 nm	Level F Impact: 6 mm steel ball launched at 45 m/s

BENEFITS

- One piece wraparound protection that can be worn over eyeglasses.
- Polycarbonate lens and frame with a panoramic field of vision.



MO-11010



EN 166 / EN 170





ARC FLASH SHIELD WITH HEAD BAND

Protective face shield to be used without a helmet.
Polycarbonate face shield.

- Arc protection class against short-circuit electric arcs.
- Head fit adjustment by milled wheel.
- Anti-scratch and anti-fogging treatments.

CAUTION: DO NOT USE FOR WELDING OPERATIONS.

Reference	Characteristics	 (mm)	
		Dimensions	Weight
MO-286	Clear face shield	L 230 x H 290	400
M-883209	Replacement face shield		
M-883298	Sweatband		

BENEFITS

- Insulating up to 1000 V.
- Arc Flash APC 1 (Box test)

FACE SHIELDS

Protection against short-circuit electric arcs. Face shield adjustable on MO-182 helmet.

CAUTION: DO NOT USE FOR WELDING OPERATIONS.

Reference	Fitting	 (mm)	
		Dimensions	Weight
MO-284	Rubber headband	L 200 x H 470	170
MO-284-C	Side clips	L 200 x H 470	170

Accessories

Reference	Characteristics
M-883210	Replacement face shield for MO-284
M-883295	Spare hardware kit (Screen milled wheel adjustment)

BENEFITS

- Fit with most type of helmet (MO-284).
- Arc Flash APC 1 (Box test).
- Insulating up to 1000 V.

EN 166 / EN 170

IEC 61482-1-2  / GS-ET29 / ANSI Z87.1

Normative marking : 2C-1.2 CATU 1B8-1-03CE 1883



MO-286

EN 166 / EN 170

IEC 61482-1-2  / GS-ET29 / ANSI Z87.1

Normative marking :

FRAME: CATU 166 8 B CE 1883

SCREEN: 2C-1.2 CATU 1B8-1-03CE 1883



MO-284



MO-284-C





INSULATED SAFETY HELMETS

Safety industrial helmet. Standard sizes 53 to 62.
Trim along the inside for added comfort.
Multiple adjustments for a perfect fit headband.

EN 397
EN 50365 
ANSI Z89.1
CE



Reference	Color	 g
		Weight
MO-182/1-B	WHITE 	300
MO-182/1-R	RED 	300
MO-182/1-J	YELLOW 	300



MO-182/1-B



MO-182/1-R



MO-182/1-J

BENEFITS

- Deformable shock-resistant ABS helmet with "gutter" brim.
- Side slots for mounting hearing protection.
- 4 points textile head base. Safety chin strap.

ACCESSORIES FOR MO-182/1

Reference	Description
M-881836	Headband
MO-155	Noise canceling earmuffs



MO-155

ELECTRICIAN HELMETS FOR WORK AT HEIGHT

Protects against vertical and side impacts. Heigh comfort.

Reference	Color	 g
		Weight
MO-183-BL	WHITE 	455
MO-183-RL	RED 	455



MO-183-BL



MO-183-RL

BENEFITS

- Deformable shock-resistant helmet in polycarbonate.
- Head fit adjustment by milled wheel from 53 to 63 cm.
- Chinstrap with an easy adjustment buckle. Design to tear off if hooked. (> 25 daN).
- 6-points textile head base.



HEAD PROTECTION

ELECTRICIAN HELMETS WITH INTEGRATED FACE SHIELD

Industrial helmet with integrated face shield. Approved for protecting against the thermal energy of an electric arc = (APC1/box test).

EN 166 / EN 170

EN 397

EN 50365 

IEC 61482-1-2  / GS-ET29 / ANSI Z89.1



Reference	Color	Anti UV
MO-185-BL	WHITE 	2-1.2
MO-185-R	RED 	2-1.2
MO-185-J	YELLOW 	2-1.2
MO-185-B	BLUE 	2-1.2
MO-185-BLM	WHITE  + Chinstrap with a chincup	2-1.2



MO-185-BL

BENEFITS

- Head fit adjustment by milled wheel from 52 to 66 cm.
- Height position adjustment.
- Panoramic face shield in anti-scratch and anti-fogging polycarbonate. Fully retractable.
- Chinstrap (with Velcro® fastening).



MO-185-R



MO-185-J



MO-185-B

NEW

Add your logo on your helmet to create a unique product for your company.



ARC FLASH HELMET
PAGE 37

ACCESSORIES FOR MO-185-...

Reference	Characteristics
M-882677	Spare face shield for MO-185
M-881836	Spare frontal padded band for MO-185
M-882671	Spare padded headband and chinstrap for MO-185
M-881837	Red headband
M-881838	White/red velcro for identification
M-87384	Black fabric bag for transporting and protecting helmets and shields. Convenient for MO-185, MO-180, MO-182, MO-183, MO-284, and MO-286.
MO-883208	Arc Flash side protection

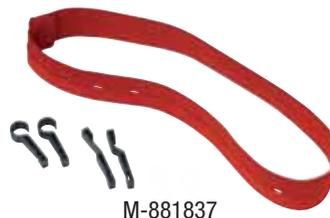

M-881837



M-881838



M-87384



MO-883208

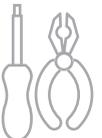

HEADLAMP FOR HELMET

Headlamp for helmets MO-185, MO-180-ARC and MO-182/1. Compatible with the majority of helmets on the market.

Reference	Amount of LEDs	Ingress protection level	
			Weight
MS-124/2	5	IP X 4	86

EN 60825-1 / EN 60529

RoHS 2002 / 95/EC

REACH



BENEFITS

- Autonomy at full power: 100 h.
- Light distance at full power: 35 m.
- Maximum light output: 70 lumens/35 m.
- Textile headband for use as a usual headlamp.
- Supplied with universal adhesive support for helmet.
- Orientable.





HEAD PROTECTION

ATEX LED HEADLAMP FOR HELMETS

II 1 G Ex ia IIC T4 Ga.



Can be worn either on the head or on different helmet models:

ATEX compliant :

European Category 1 Certificate (Zone 0)

II 1 G Ex ia IIC T4 Ga.

- Long lighting duration : 47 h (low intensity), 19 h (strong intensity),
- Material: ABS – high impact resistance,
- Range: 19 to 28 m,
- Light output: strong mode 30 lm, low mode 14 lm.

Reference	Amount of LEDs	Feature	g
			Weight
MS-126	3	ATEX	90



BENEFITS

- Adjustable head.
- Headband: choice of standard fabric or rubber for a firm fit of the lamp on helmets.
- 3 white LEDs.

HEARING PROTECTION

Reusable earplugs.

Reference	Tie	SNR	Set
MO-151	With cord	30 dB	5
MO-151/100	With cord	30 dB	100
MO-152	With hoop	24 dB	1



MO-151



MO-152

INSULATING RUBBER GLOVES AN ESSENTIAL CHOICE FOR SAFETY!



COMPLIANCE

Insulating gloves offer personal protection against electrical shocks when working on or near live wires. They must comply with the IEC 60903:2014 and **EN 60903:2003 standards**. As a result, they undergo various voltage, ageing, and mechanical testings.

The gloves are individually tested and delivered in a sealed UV protecting plastic bag.



GLOVE TYPES, CLASSES, AND CATEGORIES

There are **2 main types of insulating gloves**:

- **Rubber gloves** provide high dielectric performance. They must be used with leather gloves for mechanical protection.
- **Gloves with mechanical properties** offer superior mechanical protection against punctures and tears. They eliminate the need for overgloves.

WELLFIT FINISH

NEW

Soft, supple, durable and ergonomic with high flexibility for an easy work. With an ergonomic shape our gloves are suitable for any type of hand and are soft and supple which allows good dexterity.

A CHOICE OF FULL SIZE

Sizes from 7 to 12 can cover all requirements (Female / Male).

BI-COLOR

Bi-color gloves on class 1/2/3/4 allows contrast to rapidly detect any excessive abrasion, cut, tear and other mechanical surface damage that could alter the dielectric properties of the glove.

CLEAR-MARKING

Color label by class.

DATAMATRIX CODE

Traceability of the gloves enabling to easily know if the gloves are compliant, the next re-test dates, the test reports, user instruction, data-sheet.

ROLLED CUFF

Rolled cuff for comfort & ease of donning and doffing.

CHARACTERISTICS OF SYMBOLS



- Label with a double triangle symbol IEC 60 417-5216, suitable for live working.



- Label with a mechanical hammer symbol: suitable for insulating gloves with additional mechanical properties.



All our gloves provide use with greater comfort and hygiene.

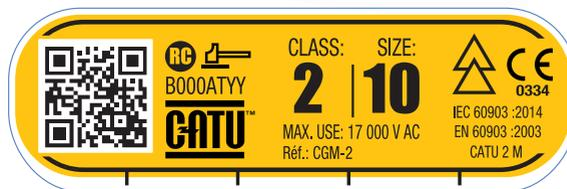
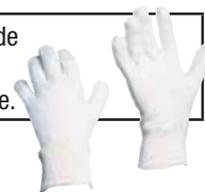

INSULATING RUBBER GLOVES, AN ESSENTIAL CHOICE FOR SAFETY!

Larger marking area for user (date of first use or re-test date)

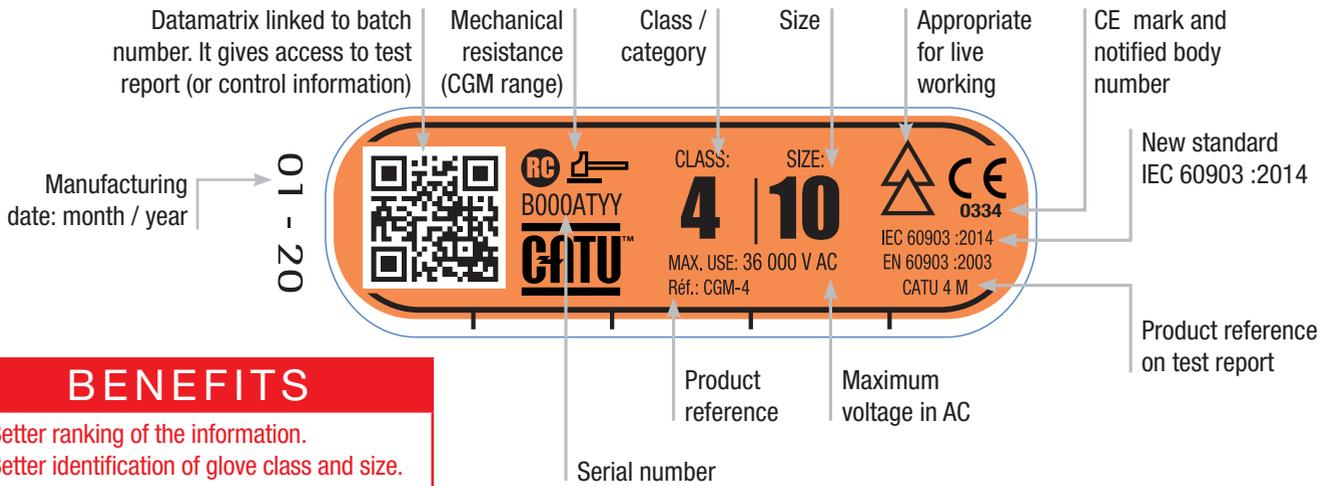

BENEFITS

- Better ranking of the information.
- Better identification of glove class and size.
- Use of the normative color label.

CONVERSION TABLE FOR INSULATING RUBBER GLOVES AND OVERGLOVES

NEW

Gloves	Reference	GLOVES sizes	OVERGLOVES sizes	sizes	OVERGLOVES reference	
	CG-05- ^(*)	A = 8	8		CG-981- ^(***)	
	CG-10- ^(*)	B = 9	9			
		C = 10	10			
		D = 11	11			
	CG-1- ^(**) -NR	7	8		CG-991- ^(***)	
	CG-2- ^(***) -NR	8				
	CG-3- ^(***) -NR	9				
	CG-4- ^(****) -NR	10				10
		11				11
		12	12			

(^{*}) Complete by size code A=8, B=9, C=10, D=11. (^{**}) Complete by size code 07 to 12 (Sizes 7 and 12 on request). (^{***}) Complete by size code 08 to 12 (Size 12 on request). (^{****}) Complete by size code 09 to 12 (Size 12 on request). To find out your hand size, please refer to page 222.



INSPECTION AND STORAGE OF INSULATING GLOVES

All insulating gloves must be visually inspected after inflation and before each use.

For Classes **0** and **00**: The tests consist of an air inflation test and a visual inspection when the glove is inflated. The dielectric test is not required, but it may be performed at the owner's request. For Classes **1**, **2**, **3**, and **4**: when in use, a glove should not be used without having been tested within the last six months. Normal testing periods are between 30 and 90 days.

An inspection of the inner gloves is also recommended. Gloves should be stored in their packaging, without being compressed or folded. They should not be stored near a heat source. Storage temperature: 10°C to 21°C.

UP TO 12 MONTHS !

CATU guarantees storage of gloves for up to 12 months * without the need to retest them. So, management is optimized and simplified.

* In compliance with the international standard IEC 60903:2014, the recommendations established by the manufacturer on the storage and periodic maintenance of insulating gloves prevail in the informative annex. CATU extends the duration of storage for all its ranges and for each class of gloves to 12 months, from their date of manufacture. From the date of first commissioning, the usual recommendations for use and periodic maintenance remain unchanged. Gloves are delivered in an anti-UV bag.

INSULATING RUBBER GLOVES

Use silicon leather over gloves, ref. CG-981 (class 0 and 00), CG-991 (class 1 to 4).

PRO

EN 60903:2003

IEC 60903 : 2014



Short gloves 28 cm, rolled cuff

Reference	Class			Category	Arc flash class 00 only		Color
		Voltage (AC)	Voltage (DC)			Length	
CG-00-(*)-R-28	00	≤ 500 V	≤ 750 V	AZC	6 cal, class 1. Battery acid resistance	280	Red exterior, beige interior.
CG-0-(*)-R-28	0	≤ 1 000 V	≤ 1 500 V	AZC		280	

(*) Complete by size code 07 to 12 (Sizes 7 and 12 on request).

NEW



Gloves 36 cm, cut edges

Reference	Class			Category		Color
		Voltage (AC)	Voltage (DC)		Length	
CG-05-(*)	00	≤ 500 V	≤ 750 V	AZC	360	Beige
CG-10-(*)	0	≤ 1 000 V	≤ 1 500 V	AZC	360	

(*) Complete by size code A=8, B=9, C=10, D=11.



Gloves 36 cm, rolled cuff

Reference	Class			Category		Color
		Voltage (AC)	Voltage (DC)		Length	
CG-1-(*)-NR	1	≤ 7 500 V	≤ 11 250 V	AZC	360	Bicolour: orange exterior, beige interior.
CG-2-(**)-NR	2	≤ 17 000 V	≤ 25 500 V	RC	360	
CG-3-(**)-NR	3	≤ 26 500 V	≤ 39 750 V	RC	360	
CG-4-(***)-NR	4	≤ 36 000 V	≤ 54 000 V	RC	410	

(*) Complete by size code 07 to 12 (Sizes 7 and 12 on request). (**) Complete by size code 08 to 12 (Size 12 on request). (***) Complete by size code 09 to 12 (Size 12 on request).



MECHANICAL AND ARC FLASH INSULATING GLOVES

Insulating gloves with higher mechanical properties for working in full safety without leather overgloves. Protection against thermal hazards from an electrical arc. Length 36 cm, cut edge.

EN 60903:2004 / IEC 60903:2014

ASTM F2675

ATPV 12 and 40 cal/cm²

IEC-61482-1-2 APC 2

Reference	Class			Category		Color	APTV
		Voltage (AC)	Voltage (DC)		Length		cal/cm ²
CGM-00-(*)	00	≤ 500 V	≤ 750 V	RC	360	Bi-colour: Orange outside. Natural inside.	12
CGM-0-(*)	0	≤ 1 000 V	≤ 1 500 V	RC	360		12
CGM-1-(*)	1	≤ 7 500 V	≤ 11 250 V	RC	360		12
CGM-2-(**)	2	≤ 17 000 V	≤ 25 500 V	RC	360		12
CGM-3-(**)	3	≤ 26 500 V	≤ 39 750 V	RC	360		12
CGM-4-(***)	4	≤ 36 000 V	≤ 54 000 V	RC	410		12
CGM-4-(*)-ARC-40	4	≤ 36 000 V	≤ 54 000 V	RC	410		40

(*) Complete by size code 07 to 12 (Sizes 07 and 12 on request). (**) References to be completed by size code 08 to 12 (***) References to be completed by size code 09 to 12.

EXPERT



NEW: Also available in length 410 mm.

NEW



BENEFITS

- Protection against thermal hazards from an electrical arc. 12 cal/cm² as a standard. CGM-4-(*)-ARC-40 : 40 cal/cm² protection against thermal hazards. APC 2 (box test 7kA).

GATU



PNEUMATIC GLOVE TESTER

For compulsory control of gloves before use. Checking is done by inflating and immersing in water.

Reference	Characteristics	 g
		Weight
CG-117	Pneumatic glove tester	600
M-86484	Set of 2 rings	-



CG-117

GLOVE BOX

- Plastic box for insulating gloves from class 00 to 4.
- Ensure for the gloves a good mechanical protection against shocks and UV radiation.
- Box can be fixed on a wall, in a substation, or be used as a carrying box and a storage box.

Reference	 (mm)	 g
	Dimensions	Weight
CG-35/2 *	101 x 224 x 476	900

* Includes precautions for use on tape positioned according to the language (English, French, Spanish, German, Italian, Portuguese, Arabic Dutch, Chinese, Russian).



BENEFITS

- Velcro® strap to hold gloves correctly.
- Glove maintenance recommendation.

STORAGE BAG

Made of reinforced waterproof fabric for transport of rubber gloves in vehicles and tool boxes.

Reference	Class	 (mm)	 g
		Dimensions	Weight
CG-36-1	00 to 1	420 x 180	185
CG-36-2	2 to 4	460 x 200	225



BENEFITS

- Dimensions suitable for various glove thicknesses.
- Transparent pocket at the back and loop for belt and hook.

OVERGLOVES

Mechanical protection of the insulating rubber gloves.

Reference	Size	
		Weight
CG-981-(*) for insulating gloves class 0 and 00	8	160
	9	
	10	
	11	
CG-991-(*) for insulating gloves class 1 to 4	8	200
	9	
	10	
	11	
	12	

(*) References to be completed by size 08 to 12.
See the conversion table page XX for the correct size based on the insulated glove.

BENEFITS

- Silicon grain leather, Kevlar thread, very flexible. With Velcro®.
- Large protective cuff in chrome tanned hide. With Velcro®.
- Very good dexterity level : 5 (according to EN 420). Over gloves provide the insulating glove with mechanical protection while being resistant to flame and contact heat of 100 ° C for 10 s according to EN 407.

UNDERGLOVES NOMEX III® “ARC FLASH” MODEL

UNDERGLOVES

These washable cotton undergloves improve the use of the insulating gloves. They bring the best held, hygiene and a greater comfort. Washable cotton undergloves.

Reference	Size	
		Weight
CG-80-(*)	H = Men / F = Women	28

(*) References to be completed by size H or F.

MITTENS

Fingerless gloves shape allowing to keep the highest of dexterity.

Reference	Size	
		Weight
CG-81	Size unique	20



CG-981



CG-991



Insulating gloves for “Arc Flash” protection page 38



BENEFITS

- Limit the effects of perspiration.
- Allow highest dexterity.

EN 407:2004
412X4X
EN 388: 2016
2122X
EN420(5)
CE



INSULATING BOOTS



INSULATING BOOTS

Provide electrical insulation protecting from "step voltage".
No metallic element. Designed with improved comfort and ergonomics.
Height : 32 cm, Weight : 2.5 kg (size: 42).

Reference	Class	Voltage	Size
MV-137-(*)	2	17 000 V AC	EU:35,36,37,38,39,41,42,43,44,45,46,47,50 UK: 3,4,5,6,7,8,9,10,11,12,13,15
* Add size to the reference. Ex: MV-137-43.			

BENEFITS

- Provides protection against step voltage. Each boot is tested to 20 kV AC.
- Design to prevent clogging.
- Non-slip vulcanized rubber.

INSULATING OVER SHOES

Overshoes which provide electrical insulation to protect operators against the risk of a current flow from the feet to the ground or a step voltage. Adapted to a temporary and frequent use.

MV-138 weight: 1,9 kg (size L).

MV-139 weight : 1,4 kg (size L).

Reference	Class	Voltage	Size
MV-138-(*)	1	7 500 V AC	M (39 to 42), L (43 to 45), XL (46 to 48)
MV-139-(*)	3	26 500 V AC	M (39 to 42), L (43 to 45), XL (46 to 48)
* Add size to the reference. Ex: MV-139-M.			

BENEFITS

- Class 1: every boot tested to 10 kV AC.
- Class 3: every boot tested to 30 kV AC.
- Can be used on footwear.
- Slip resistant sole. Lightweight.



EN ISO 20345:2011
EN 50321-1:2018 
CE



MV-137



EN ISO 20347:2012
EN 50321-1:2018 
ST HTA 70B (RTE SERECT) ind. E
CE



MV-138



MV-139



SAFETY SHOES WITH INSULATING SOLE FOR INDOOR AND DRY ENVIRONMENT

Shoes with external sturdy leather and internal sanitized® lining highly breathing liner microphone. Anti-penetration textile sole. Protection cap 200 J. Skid resistance:SRC. Torsion resistant sole.

Reference	Type	Size	Class	Use
MV-222-*	Low	39 to 47	0: 1 000 V AC	Industry, construction, bold and smooth floors
MV-223-*	High	39 to 47	0: 1 000 V AC	

* Add size to the reference. Ex: MV-222-43.

100% TESTED 5 KV before shipment.

Shoes with polyurethane rod and antibacterial lining, ventilated 3D mesh neighborhoods. Anti-penetration textile sole. Protection cap 200 J. Skid resistance: SRC.

Reference	Type	Size	Class	Use
MV-226-*	Low	40 to 47	0: 1 000 V AC	Industry, logistics and transport, services and communities.
MV-227-*	High	40 to 47	0: 1 000 V AC	

* Add size to the reference. Ex: MV-227-43.

BENEFITS

- Each shoes is tested at 5 kV. Anti-penetration.
- Tested to 5 kV according to EN 50321, to 14 kV according to ASTM F2412, to 18 kV according to ASTM F2413.

MV LIVE WORKING SAFETY SHOES AGAINST ELECTRICAL HAZARDS OF STEP VOLTAGE

Anti-penetration textile (1430 N). SB P HRO WRU E FO SRC marking. 100% electrically tested. On network MV, the Electrical Hazard Resistance is 18 kV, according to ASTM F2413:2018.

THESE SAFETY SHOES ARE ESPECIALLY DESIGNED FOR USE IN A DRY AREA. DO NOT USE THEM IF THERE IS A RISK OF MOISTURE INGRESS.

Reference	Size	Electrical Hazard Resistance
MV-232/1-*	38 to 47	18 kV

* Add size to the reference. Ex: MV-232/1-43.



MV-222



MV-223



MV-226



MV-227



MV-232/1

NEW

EN ISO 20345:2012
ASTM F2413-11 (18 kV)



BENEFITS

- Sole textile anti-penetration mid sole 1430 N.
- Protective toe cap 240 J (composite).
- Rigid anti-slip sole ideal for working on ladder and tower.





IN ACCORDANCE WITH STANDARDS

The insulating mats provide operators with individual and collective protection. Made of elastomer, they are used to cover the ground for the electrical protection of operators during work or interventions on electrical installations.

In accordance with IEC 61111: 2009 (Live working tools – insulating mats category C: Resistant to very low temperature -40°C).

CLASS AND MAXIMUM VOLTAGE

Class	Voltage (AC)	Voltage (DC)
0	≤ 1 000 V	≤ 1 500 V
1	≤ 7 500 V	≤ 11 250 V
2	≤ 17 000 V	≤ 25 500 V
3	≤ 26 500 V	≤ 39 750 V
4	≤ 36 000 V	≤ 54 000 V

IEC 60417-5216

Label with a double triangle symbol means : SUITABLE FOR LIVE WORKING according to IEC 60417-5216

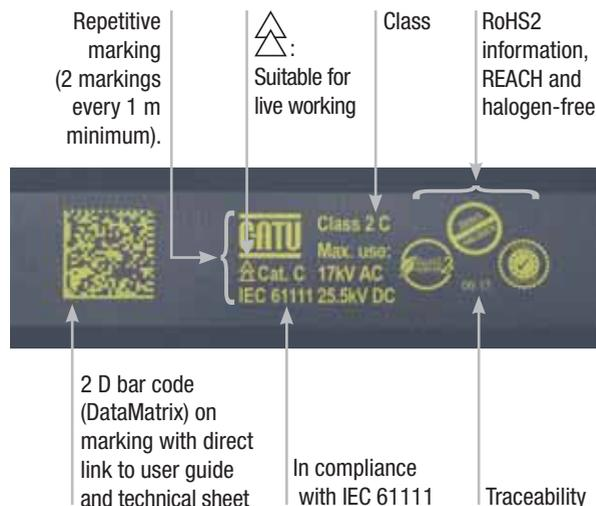

RECOMMENDATIONS FOR USE

Storage/Transport

Insulated mats should be properly stored to avoid the risk of damage to the insulating material. Do not bend insulating mats. Do not store or use close to excessive heat. Do not expose to direct sunlight for long period. Storage temperature: 10°C to 21°C.

Before use

Visually inspected by the user. If the insulating mats is dirty, wash it with soap and water. Dry it with respect of operating temperatures.

In use

Operating temperatures: -40°C to 55°C. Avoid contact with chemical products. Place the mat on a clean, smooth floor, devoid of aggressive elements for insulation. Position the feet: The operators feet must be in the center of the insulating mat.

Periodic inspection

Insulating mats should not be used without having been electrically tested within the previous twelve months preceding with the exception of class 0. Only visual inspection is required for class 0.

LV INSULATING MATS-CLASS 0

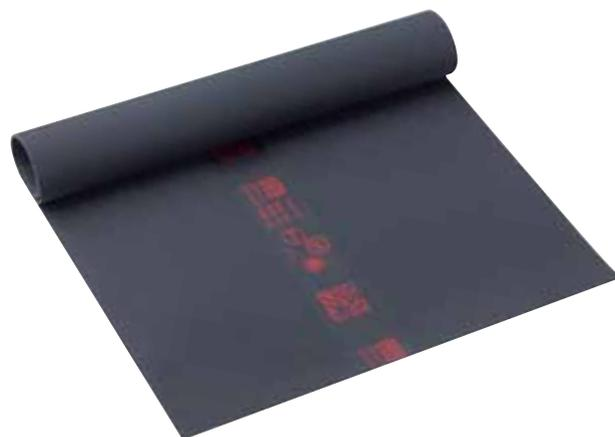

MV INSULATING MATS-CLASS 2,3 AND 4



INSULATING MATS

Insulating mats with unique and innovative properties. The insulating material offers the best possible technical and electrical insulation characteristics. The improvement of the elastomer formulation allows to reach the drastic properties of "C" category of the IEC 61111: 2009 standard: mats do not degrade even when folded at very low temperatures (-40°C).

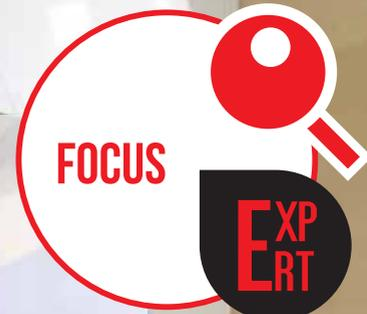

<p>RoHS2 compliant The material does not contain Lead, Mercury, Cadmium, Hexavalent Chromium, Biphenyl Polybrominate (PBB), Biphenyl Polybrominate Ether (PBDE).</p>	
<p>REACH compliant The material does not contain any of the 163 substances considered to be Highly Hazardous Chemical Substances (HHCS).</p>	
<p>Zero halogen The material does not contain Fluorine, Chromium, Bromine and Iodine. The absence of halogen is a positive indicator for the health and safety of the operator in case of fire.</p>	



The normative marking is repeated at least twice per linear metre, thus ensuring good visibility on the ground. Marking color is different according to the classification:

- Class 0
- Class 2
- Class 3
- Class 4

100% of cut and rolled mats are tested after manufacturing.



- 1** Compliant with the standard IEC 61111 and the properties category "C" for bendability at very low temperatures (- 40° C).
- 2** Mats compliant with RoHS2 and REACH Directives and not containing halogen (therefore not dangerous) for the operator in case of fire).
- 3** 2D bar code (DataMatrix) on marking with direct link to user guide, technical sheet and periodic maintenance conditions.

Standards and References:

- **IEC 61111:** "Live working. Electrical insulating matting". Category "C".
- **RoHS2:** Directive 2011/65/EU Annexe II.
- **REACH:** List of HHCSs (High Level Product) based on the European Chemicals Agency's publication (ECHA) in 2015 and the regulation N° 1907/2006 concerning REACH.
- **Zero Halogen:** Tests based on IEC 14582 guidelines.



INSULATING MATS

LV AND MV INSULATING MATS

All references are in accordance with IEC 61111 standard and to specific properties of the "C" category (extremely low temperature folding test at - 40 °C).

- IEC 61111: 2009 international standard is the single international standard concerning insulating mats.
- RoHS2 compliant.
- REACH compliant.
- Zero Halogen.
- 2 D bar code (DataMatrix) on marking with direct link to user guide and technical sheet.
- Insulating mats must be chosen according to the maximum service voltage of the installation.
- High dielectric quality.
- Rubber material with non-slip surfaces on both sides.
- Operating temperature: - 40 to + 55 °C
- Storage temperature: + 10 to + 21 °C
- Repetitive marking (2 markings every 1 m minimum).



IEC 61111: 2009



Reference	IEC/EN 61111	 (mm)	 (m)	 kg	Service Voltage V ⁽¹⁾	
		Thickness	Width x Length	Weight	AC	DC
MP-11/66	Class 0	2.2	0.6 x 0.6	1	≤ 1 000	≤ 1500
MP-11/16			0.6 x 1	1.8		
MP-11/26			0.6 x 1.2	2		
MP-11/11			1 x 1	3		
MP-11/21			1 x 1.2	3.4		
MP-11/22			1.2 x 1.2	4		
MP-60/02-5			0.6 x 5	9		
MP-60/02-10			0.6 x 10	18		
MP-100/02-5			1 x 5	15		
MP-100/02-10			1 x 10	30		
MP-120/02-5			1.2 x 5	17		
MP-120/02-10			1. x 10	34		



Reference	IEC/EN 61111	 (mm)	 (m)	 kg	Service Voltage V ⁽¹⁾	
		Thickness	Width x Length	Weight	AC	DC
MP-20/66	Class 2	2.6	0.6 x 0.6	1.5	≤ 17 000	≤ 27 500
MP-20/16			0.6 x 1	2.4		
MP-20/26			0.6 x 1.2	2.8		
MP-20/11			1 x 1	3.9		
MP-20/21			1 x 1.2	4.7		
MP-20/22			1.2 x 1.2	5.6		
MP-60/20-5			0.6 x 5	12		
MP-60/20-10			0.6 x 10	24		
MP-100/20-5			1 x 5	19.5		
MP-100/20-10			1 x 10	39		
MP-120/20-5			1.2 x 5	23.5		
MP-120/20-10			1.2 x 10	47		
MP-42/66	Class 3	3.2	0.6 x 0.6	1.8	≤ 26 500	≤ 39 750
MP-42/16			0.6 x 1	2.9		
MP-42/26			0.6 x 1.2	3.5		
MP-42/11			1 x 1	4.5		
MP-120/03-1			1 x 1.2	5.4		
MP-120/03-2			1.2 x 1.2	6.5		
MP-60/03-5			0.6 x 5	14		
MP-60/03-10			0.6 x 10	28		
MP-100/03-5			1 x 5	22.5		
MP-100/03-10			1 x 10	45		
MP-120/03-5			1.2 x 5	27		
MP-120/03-10			1.2 x 10	54		
MP-60/05-1	Class 4	5	0.6 x 1	4.5	≤ 36 000	≤ 54 000
MP-120/05-0			0.6 x 1.2	5.4		
MP-100/05-1			1 x 1	8.9		
MP-120/05-1			1 x 1.2	10.5		
MP-120/05-2			1.2 x 1.2	12.6		
MP-60/05-5			0.6 x 5	22		
MP-60/05-10			0.6 x 10	45		
MP-100/05-5			1 x 5	44.5		
MP-100/05-10			1 x 10	89		
MP-120/05-5			1.2 x 5	52.5		
MP-120/05-10			1.2 x 10	105		

(1) In polyphase networks, it corresponds to the nominal network voltage between phases. In operating field. If there is no possibility of exposure to a voltage between phases and if the possible voltage remains limited to the voltage between phase and earth, this voltage between phase and earth can be considered as the nominal voltage.



BAGS FOR INSULATING MAT

Specially designed for carrying and protecting insulating mats. Fitted with a shoulder strap.

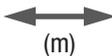
Reference	Use	 (m)	
		Dimensions	Weight
MP-01	For insulating mats of 0.60 m wide maxi.	0.7	450
MP-02	For insulating mats of 1.20 m wide maxi.	3	700



MP-01



MP-02

BENEFITS

- Transparent pocket for user instructions and storage identification.
- Hand carrying straps and shoulders carrying strap.

STRAP FOR INSULATING MAT

Black textile strap and hook-and-loop strap. Simple and quick to use thanks to the holding loops at each end. Stores up to 2 mats.

Reference	 (mm)	
	Dimensions	Weight
MO-160	530 x 38	100
MO-161	1 700 x 38	200



MO-161



MO-160

BENEFITS

- Instruction manual for insulating mat printed on the strap - pictograms and texts in French and English.

STORAGE TUBE FOR INSULATING MAT

Adjustable length storage tube for any mat width up to class 3. Adjustable carrying strap. Delivered with wall mounting accessories.

Reference	 (mm)	
	Dimensions	Weight
MP-20	630 x 1 260	600





INSULATING PLATFORMS (INDOOR MODELS)

Reference	Class	Rated insulation	Max work load kg	Standards	↑↓ (mm)	kg
					Height	Weight
CT-7-25/1	4	≤ 36 kV	85	UNE 204 001	220	3.7
CT-7-40/1	4	≤ 45 kV	85	UNE 204 001	260	3.9

CT-701	4 pads set
--------	------------

BENEFITS

- Moulded insulating material, one-piece.
- Top 50 x 50 cm.



INSULATING PLATFORMS (INDOOR MODEL)

Adapted to High Voltage.

Reference	Rated insulation	Max work load kg	↑↓ (mm)	kg
			Height	Weight
CT-7-63	≤ 63 kV	85	515	3.35

BENEFITS

- Removable feet with rubber pads.
- Moulded solid plate of insulating material 52 x 52 cm, thickness 40 mm.



INSULATING PLATFORM (OUTDOOR MODELS)

Reference	Rated insulation	Max work load kg	↑↓ (mm)	kg
			Height	Weight
CT-9-25	≤ 24 kV	100	350	6
CT-9-45	≤ 45 kV	85	435	6.5
CT-9-63	≤ 63 kV	85	515	7

BENEFITS

- Moulded solid plate of insulating material 52 x 52 cm, thickness 40 mm.
- Insulating skirts.
- Feet with rubber pads.





ARC FLASH PROTECTION THE SOLUTION FOR COMPLETE ELECTRIC ARC PROTECTION.

THE ARC FLASH PHENOMENON.

An electric arc follows a short circuit. It produces nearly instant effects with serious consequences for an operator not wearing proper protection.

As with an explosion, and as well as the high level of heat released, an arc flash produces the following effects:

- detonation,
- shockwave,
- emission of ultraviolet radiation,
- projection of debris and molten particles.

When electric arc danger exists, heat-resistant clothing must be worn. The arc's characteristics are given by:

- **The Arc Thermal Protective Value (ATPV) of an open arc, expressed in cal/cm² according to NFPA 70 E, ASTM standards, and IEC 61482-1-1 (Open arc).**

or

- **The Arc Protection Class (APC 1 or 2) with a constrained arc according to IEC 61482-1-2 (Box test).**



Flame-retardant clothing in case of exposure to an electric arc, conforming to IEC 61482-2 and the NFPA 70E regulation.

PROTECTION AGAINST ARC FLASH

The following inputs are used to determine the proper equipment for protecting against an electric arc:

- The maximum fault current value.
- The phase/ground rated voltage at the site of the risk.
- The distance between the source of the arc and the reception surface.
- The AC cycle number and the mono or three-phase circuit type.
- The location where the arc is produced (confined space). After recording these parameters, we can estimate the level of risk and determine the proper protective clothing and PPE to use: ATPV 12 to 100 cal/cm² or APC 1 or 2. For more information, please contact our technical department.



ARC FLASH FACE SHIELD KIT

APC 2 - ATPV 12 cal/cm²

Composition	Reference: KIT-ARC-01	kg
		Weight
		1.5
MO-187	1 Face shield with chincup APC 2 and 12 cal/cm ² , absorbs > 99.9% of harmful UV radiation, 60% light transmission, tested to ASTM F 2178 specifications	
MO-182/1-B	1 ABS white helmet electrical insulation EN397, EN 50365, ANSI Z89.1 20 kV	
M-87384	1 carrying bag for face shield and helmet	

BENEFITS

- Electrician ABS helmet.
- Large field of view.
- Anti-UV and polycarbonate 1.5 mm thickness.
- Chin protection.

EN 166 / EN 170 / EN 397

EN 50365

IEC 61482-1-2 / GS-ET-29 / ANSI Z 89.1

ASTM F2178 / IEC 61482-1-1

NFPA 70E



ARC FLASH HELMETS

The unique all integrated helmet with Arc Flash face shield on the market. Patented by CATU.

Reference	Characteristics	kg
		Weight
MO-180-ARC-4	Face shield 4 cal/cm ² APC 2 Light transmission > 75%	0.79
MO-180-ARC-12	Face shield 12 cal/cm ² APC 2 Light transmission > 60%	0.79
MO-180-ARC4 VISOR	Face shield 4 cal/cm ²	-
MO-180-ARC12 VISOR	Face shield 12 cal/cm ²	-

BENEFITS

- Mechanical & Electrical Protection helmet EN 397 EN 50365 - 1 000 V / ANSI Z 89.1 - 20 kV.
- IEC 61482-1-1 / IEC 61482-1-2 arc protection. EN166 and EN170 protection.
- Flexible and compact fabric protection Arc Flash.
- Optimal colour recognition and visibility (MO-180-ARC-4). Retractable screen and neck protection.

EN 166 / EN 170 / EN 397

EN 50365

IEC 61482-1-2 / GS-ET 29 / ANSI Z 89.1

ASTM F2178 / IEC 61482-1-1

NFPA 70E



Retractable screen and flaps



INSULATING GLOVES FOR ARC FLASH

Reference	Class			Category		APTV
		Voltage (AC)	Voltage (DC)		Length	cal/cm ²
CGM-4-(*)-ARC-40	4	≤ 36 000 V	≤ 54 000 V	RC	410	12

(*) Complete by size codes 07 to 12 (Sizes 07 and 12 on request).

BENEFITS

- Safety first by providing best in class insulating gloves (class 4) with best thermal (40 cal/cm²) protection. Electrical and mechanical protection certified according to IEC 60903 Electrical insulating gloves. Thermal protection certified according to IEC 61482-2 against the thermal hazards of an electric arc : IEC 61482-1-2:APC Class 2 & ASTM F2675 (identical test to IEC 61482-1-1) 40 cal/cm².
- Comfort of use: Softness and dexterity enabling to easily handle your electronic equipments and tools.
- Traceability : QR code included facilitating the fleet management with the employee user, compliance with re test date reducing risk of accidents.



NOMEX III® UNDERGLOVES

100% Nomex III® fire-resistant and heat-resistant undergloves. Protects the hands against heat of up to 100°C. Ideal protection for "Arc Flash" equipment.

Reference	Characteristics		
		Set	Weight
CG-37	One size	Includes 5 pairs	32

BENEFITS

- High performance synthetic Nomex III® fibre.



Fire protection

NEW

ARC FLASH AND MULTI-RISK LONG SWITCHING JACKET

Designed to be worn on top of the usual clothing, for short operations (i.e.: power-breaking operations, live working on electrical vehicle batteries...). This long jacket offers the protection required by the French Organism of Live Working.

CAUTION, ONLY THE AREAS COVERED BY THE SWITCHING JACKET ARE PROTECTED.



Reference	Size
AFG-2300-*	S, L, 2XL or 4XL
(*) To be completed by the sizes: S, L, 2XL, 4XL.	

BENEFITS

- An adjustable hood for a better protection of the head and the neck in case of a higher risk, to be wear with a visor or a helmet.
- A Velcro® fastening along the entire length: easy to open and close.
- A back length of 121 cm to ensure an efficient protection of the operator down to the knees.

ARC FLASH AND MULTI-RISK PARKA

Outdoor multi-risk protective garment.

Reference	Size
M-883374	S
M-883377	M
M-883378	L
M-883379	XL
M-883380	2XL
M-883381	3XL



EN ISO 11611



EN ISO 11612



EN 1149-5



EN ISO 13034-6



IEC 61482-2
APC 2



EN ISO 20471 (3)



EN 343 (3-2)

NFPA 70E



IEC 61482-2:2018



APC 1 / ATPV 12 cal/cm²

ISO 11612:2015 A B1 C1 E2 F1



EN 1149-5:2018



ASTM F1959





ARC FLASH AND MULTI-RISK PROTECTIVE CLOTHING

The CAT'ARC APC 1 and ATPV 12 cal/cm² garments are daily workwear and maintain optimal safety for operators being exposed to the danger of electric arc during live-working or while switching. The protection offered by CAT'ARC is multiple (Arc-Flash, heat and flames, welding, and anti-static) ensuring the operators full protection against the identified risks.

Tips and tricks to optimize comfort and safety of operators: numerous pockets for easy access to tools, high collar for an effective neck protection, crotch and knees reinforcements for a good resistance.



- ① An anti-panic zip in order to quickly and easily remove the garment if needed after an Arc Flash accident.
- ② Red colored zip is an extra feature for a safer PPE: no red visible = a PPE that is being worn properly.
- ③ Smart reinforcements at crotch and knees for a more resistant and durable garment.



ARC FLASH AND MULTI-RISK CAT'ARC GARMENTS



CAT'ARC clothing: Developed and tested in accordance with current standards, the range offer a multi-risk protection (arc flash, heat and flame, welding, anti-static). Fabric : 80% flame retardant treated cotton, 19% polyester, 1% anti-statique fiber - 300 g/m².

CAT'ARC kits for arc flash protection: Complete ready-to-use kits provide a comprehensive protection against the thermal effects of an arc flash.

NFPA 70E



IEC 61482-2:2009



APC 1 / ATPV 12 cal/cm²

ISO 11612:2015 A B1 C1 E2 F1



ISO 11611:2015 Class 1



EN 1149-5:2018



ASTM F1959

ASTM F1506



BENEFITS

- **EVERYDAY COMFORT:** Selected fabric and designed to ensure that operators are able to wear the garments for a full working day.

CATU provides the possibility of CAT'ARC garment customization to create a unique product with your logo.



AFG-BELT

AFG-1001

Reference	Description	Sizes
AFG-2000-*	Jacket	XS to 5XL
AFG-2001-*	Trousers	XS to 5XL
AFG-1001-*	Coverall	XS to 5XL
(*) To be completed by the size: XS, S, M, L, XL, 2XL, 3XL, 4XL ou 5XL.		
AFG-BELT-**	Plastic buckle: non-conductive.	100 cm (Sizes XS, S, M), 110 cm (Sizes L, XL, 2XL), 120 cm (Sizes 3XL, 4XL, 5XL)
**To be completed by the size: 100 cm, 110 cm, 120 cm.		
Kits		
KIT-ARC-A-01-JP***	1 set jacket trousers CAT'ARC, 1 electrician helmet ABS white MO-182/1-B, 1 Arc Flash face shield MO-187, 1 carrying bag for face shield and helmet, 1 safety glasses clear lenses MO-11000, 1 arc flash protective hood, 1 all kit carrying bag.	S to 2XL
KIT-ARC-A-01-C***	1 Coverall Cat'Arc, 1 electrician helmet ABS white MO-182/1-B, 1 Arc Flash face shield MO-187, 1 carrying bag for face shield and helmet, 1 safety glasses clear lenses MO-11000, 1 arc flash protective hood, 1 all kit carrying bag.	S to 2XL
KIT-ARC-A-02-JP***	1 set jacket trousers CAT'ARC, 1 electrician helmet ABS white MO-182-ARC-12, 1 carrying bag for helmet, 1 arc flash protective hood, 1 all kit carrying bag.	S to 2XL
KIT-ARC-A-02-C***	1 Coverall CAT'ARC, 1 electrician helmet ABS white MO-182-ARC-12, 1 carrying bag for helmet, 1 arc flash protective hood, 1 all kit carrying bag.	S to 2XL
***To be completed by the size: S to 2XL.		



ARC FLASH PROTECTIVE CLOTHING

ARC FLASH KITS

25, 40, 65, 100 cal/cm²

Complete ready-to-use kits providing arc flash protection.

Reference	ATPV cal/cm ²	Color
KIT-ARC-25-B-(*)	25 cal/cm ²	KAKI 
KIT-ARC-40-B-(*)	40 cal/cm ²	GREY 
KIT-ARC-65-B-(*)	65 cal/cm ²	CAMEL 
KIT-ARC-100-B-(*)	100 cal/cm ²	CAMEL 

(* Reference to be completed by the size M, L or XL. Size S to 3 XL on request.

Composition of KITS	
-	1 protective set (jacket and bib overall) 25, 40, 65 or 100 cal/cm ² and tested according to the ASTM F 1506 and NFPA 70E specifications.
MO-11000	1 safety glasses EN 166/EN 170.
M-87295	1 carrying bag for the complete kit.
-	1 protective hood with integrated screen (12, 40, 65 ou 100 cal/cm ²), and tested according to the ASTM F 1506 and NFPA 70E specifications.
MO-182/1-B	1 electrician helmet EN 397, EN 50365, ANSI Z89.1 - 20 kV.

Gloves not included into the kits.



NFPA 70E



ASTM F1506

IEC 61482-2 



BENEFITS

- 4 Complete ready-to-use kits.

INSULATING GLOVES
FOR ARC FLASH
PROTECTION
PAGE 38



NEW



PPE - CPE / Arc Flash protective clothing

WORK GLOVES

Reference	Size		
		Weight	
CG-96-*	A = 8	115	3122
	B = 9		
	C = 10		
	D = 11		
CG-97-XX	Size : 09 and 10	115	3132

(*) Reference to be completed by the size of A, B, C or D.
 Mechanical protection class: Abrasion 3/5, Slicing: 1/5, Tearing: 2/5, Perforation: 2/5.
 CG-97-XX: supplied by 10 pairs of gloves per bag.

BENEFITS

- American style gloves with very soft and flexible full bloom leather allowing full finger movement.
- Tightening elastic on the back of the hand.
- CG-97 : Hand protection for risky operations. Suitable for assembly, logistics, maintenance activities.
- CG-97 : All natural bovine flower, wrist type with elastic band on the back. Good dexterity.

HANDLING & CUT RESISTANT GLOVES

Reference	Characteristics	Sizes	
CG-951-*	Handling gloves	7 to 10	4131
CG-952-*	Resistant gloves	7 to 10	4443C

(*) Reference to be completed by the size of 7 to 10.

BENEFITS

- CG-951: Knitted in grey polyamide, black nitrilfoam coating on palm and fingertips with additional pins for a better hanging. Mechanical protection 4131.
- CG-952: Knitted gloves in cut resistance technical yarns (High Density Polyethylene/polyamide/Glass fibers), heather grey, with black polyurethane coating on the palm and fingertips. Mechanical protection 4443C.
- Slim fit for better dexterity.
- 10 pairs of gloves in a bag.



EN 388:2016
 EN 420:2003 T
 A/:2009





CG-97-XX



CG-951

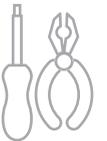

CG-952





EARTHING CLAMP/ LOCK-OUT PADLOCK SOLUTION

Secure and protect installations during maintenance operations



MT-870

THE SPECIALIST IN ELECTRICAL RISK PREVENTION

WWW.CATUELEC.COM

CATUTM
SICAME GROUP

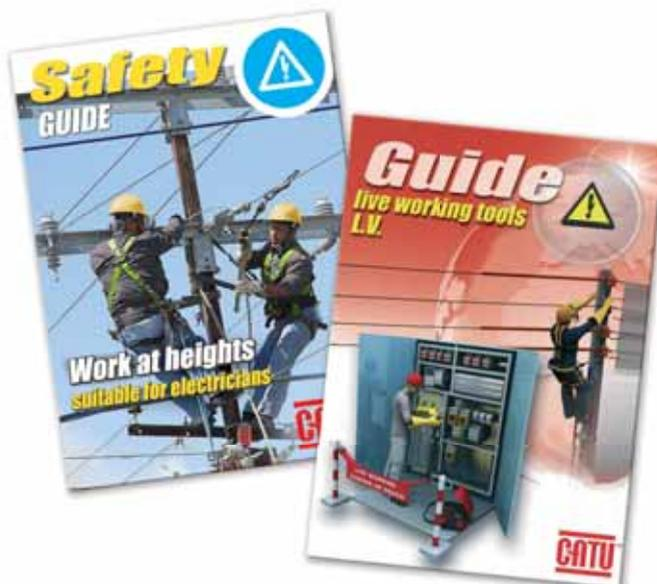

DOWNLOAD
OUR PRACTICAL
GUIDES ON:
www.catuelec.com

SAFETY EQUIPEMENT REGULATION

The European standards define the rules for all the elements of protection against the risks of work at height. Support, saving, or protecting against falls from a height.

KEY PRODUCT STANDARDS

- EN 353-1 Fall arrest grab for rigid support.
- EN 353-2 Fall arrest grab for flexible support.
- EN 354 Restraint lanyard.
- EN 355 Shock absorber lanyard.
- EN 358 Work positioning systems.
- EN 360 Retractable type fall arrestors.
- EN 361 Fall arrest harness.
- EN 362 Connectors.
- EN 363 Fall arrest systems.
- EN 813 Sit harnesses.

Removal of the minimum height of 3 m:
After a risk evaluation, protective equipment is required as soon as there is a risk of a falling.

- The use of access and positioning techniques by means of ropes must comply with the following: a working rope, a safety rope fitted with a fall arrestor system, with two separate anchoring points. Workers must be provided with suitable fall arrestor harnesses connected to both ropes. Safe descent/mounting systems with a self-locking system and a mobile fall prevention system must be provided.
- The work must be programmed and supervised so that assistance can be given immediately to the worker in the event of an emergency.

The workers must receive suitable and specific training in the operations considered and in the rescue procedures.

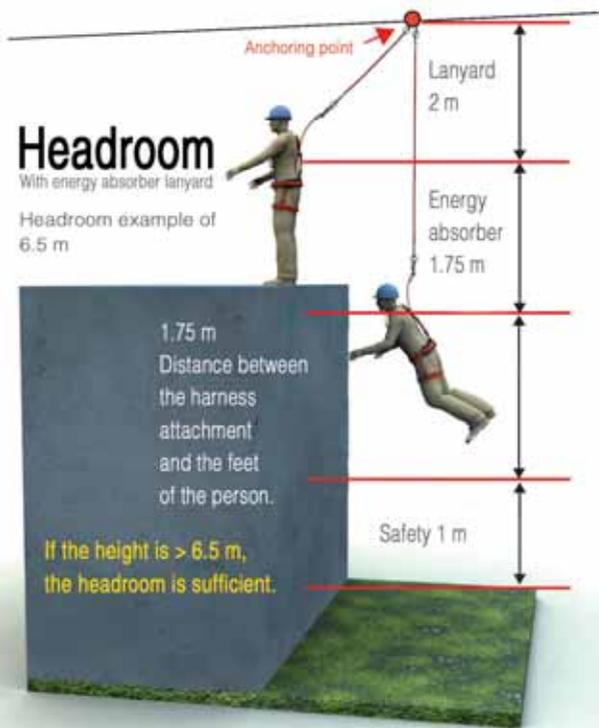

Scan to download our Safety Guide:





ATEX FULL BODY HARNESS

- Universal size. Adjustable by rectangular buckles.
- To work in ATEX atmosphere:
 - Zones 1 and 2 for gas and vapours
 - Zones 21 and 22 for dust.
- CE number : 3336.

EN 361



Reference	Size	 Weight
		Weight
MO-72-ATEX	Universal	0.8



BENEFITS

- Reinforcement on the back, shoulders and thighs.
- 1 fall arrest dorsal anchor point
- 1 fall arrest chest anchor point: composed of 2 D-rings to use together.
- Polyester straps 47 mm wide.
- Thigh straps reinforced with automatic buckles.

PRO ELECTRIC FULL BODY HARNESS

Particularly suitable for working with overhead networks.

EN 358

EN 361



Reference	Size	 Weight
		Weight
MO-563-A(*)	S	2.7
	M	
	XL	

(*) Reference to be completed by the size (example: MO-563-A-M).
Delivered in cloth bag.



BENEFITS

- 180° rotation of the positioning belt.
- Dorsal anchor point on short strap.
- Sternal anchor point on 2 butterfly harness straps, to be used together.
- Adjustable shoulder straps elastic stray.
- Automatic "clip" loops on the leg straps and belt.
- 2 attachment points for maintaining at work.
- Reinforced and adjustable leg straps
- Tools holders.
- Back-rest with storage place for the periodic maintenance sheet.

FULL BODY HARNESS

Reference	Size	kg
		Weight
MO-71	One size	1.9
Delivered in a canvas bag.		



EN 358

EN 361



BENEFITS

- Attachment points: dorsal and sternal
- 2 buckles of work positioning.
- Work positioning belt.
- Adjustable straps.
- Back-rest.



FALL ARREST KIT FOR WORKING ON PYLON

Equipment suitable for working on all types of pylons, metal structures, antenna supports or metal poles.

Composition	Reference: KIT-HAUT-05
MO-71	1 harness with 2 anchor points
MO-54010	1 double fall protection lanyard with shock absorber, length 1.2 m
MO-56009	1 support lanyard with tensioner, length 2 m
M-87295	1 carrying bag

EN 361

EN 358

EN352-2

EN355



BENEFITS

- Complete set for safe pylon working.



MO-71



MO-54010



MO-56009



M-87295



RESCUE KIT

Kit to evacuate an operator working at height being hung, anchored to his lanyard, after a fall or unable to descend by his own means. For maximum descent height of 20 meters. The kit can be handled by a single operator.

Composition	Reference: KIT-MD04-R
MO-52033	Anchoring belt
MO-346-R	Triple blocks set with 5 m rope
MO-54	Oval carabiner
MD-02	Descender
MO-69/20-R	20 m rope
MO-54004	Large opening Snap carabiner with automatic locking
MO-42/2	Bag



EN358
EN362
EN795



MO-69/20-R



MO-346-R



MO-54



MO-54004



MD-02



MO-52033



MO-42/2



BENEFITS

- Easy to use.
- A single operator is sufficient to handle the whole system and to evacuate an operator in jeopardy.

TOOL BAG FOR SAFETY HARNESS

2 pocket leather pouch.
Seam and rivet assembly.

Reference	 (mm)	 Weight
		kg
MO-32/3	270 x 230 x 100	0.835



EN 353-2

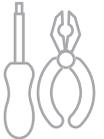

MOBILE FALL ARRESTER KIT

Kit made of 1 X MO-68/15 fall arrester with a 3 strand rope. Must be exclusively used with its special 3 strand Ø 15 mm rope fitted with a spliced upper end. To use with a harness.

Reference	Semi-static rope		 Weight
	 (m)	 (mm)	kg
MO-68/10	10	15	4
MO-68/15	15	15	6



BENEFITS

- Moves freely to the top along the rope without any manual intervention.
- Instantly arrest fall.
- Need a specific action to unlock.



MOBILE FALL ARRESTER KIT

Kit made of 1 X MO-69/10 mobile fall arrester, two carabiners with security and a semi static rope. Must be exclusively used with its Ø 11 mm rope. To use with a harness.

Reference	Semi-static rope		Static resistance	kg Weight
	↔ (m)	∅ (mm)		
MO-69/10	10	11	≥ 15 kN	4
MO-69/15	15	11	≥ 15 kN	6
MO-69/20	20	11	≥ 15 kN	8

EN 353-2



BENEFITS

- Suitable for working on inclined planes.
- Fall protection device for rope with automatic locking system.
- Must be supported on descent.
- Moves freely to the top along the rope without any manual action.

AUTOMATIC RETRACTABLE LANYARD WITH ENERGY ABSORBER

Reference	Lanyard length	Static resistance	kg Weight
	↔ (m)		
MO-591000	2	≥ 15 kN	1.6

EN 360

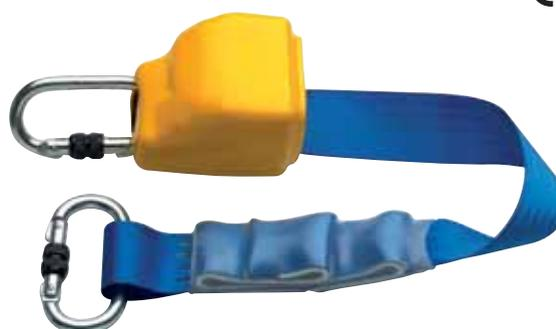

BENEFITS

- Fall protection: automatic locking retractable strap, fitted with a shock absorber. With automatic locking retractable lanyard belt and energy absorber.
- Including 2 oval carabiners.

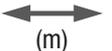

AUTOMATIC RETRACTABLE FALL ARRESTER

Reference	Length	Static resistance	
			Weight
MO-591002	10	≥ 12 kN	5
MO-592002	20	≥ 12 kN	7



EN 360
CE



BENEFITS

- Integrated braking mechanism and dissipating element. Self locking mechanism and automatic tensioning and return facility.
- Including a carabiner.

ANTI-TRAUMA SECURITY STRAPS

The straps are equipped with loops for the feet allowing the operator to stand straight. This relieves the pressure on the arteries that surround the upper legs. The two straps can be bound together with the including quick connector. Product composed of a pair of straps. Each strap is folded in a fabric case. Quick and easy installation of the device after the fall operator. Could be used with all harnesses.

Reference		
	Total length	Weight
SO-10	maxi: 1.3 m	0.2



ROPE BLOCKER WITH LEVER STRETCHER

Allows you to adjust the length of a lanyard during work. For maintenance work function. Must be only used with a 3-strand 15 mm diameter lanyard CATU MO-052.

Reference	Characteristics	
		Weight
MO-61	Manual stretcher	0.450



EN 358
CE





TETHER ROPE WITH TENSION DEVICE

EN 358
CE

Ideal for all horizontal works, and maintaining at work.

Reference	↔	∅	kg
	(m)	(mm)	Weight
MO-56009	2	12	0.750

BENEFITS

- Tensioning device: A double-locking system instantly stops the rope.
- Polyamid rope.
- Connector made of light alloy with double safety.



FORKED LANYARD WITH ENERGY ABSORBER

EN 355
CE

Fall protection function.

Reference	↔	↔	→	kg
	(m)	(m)	\vec{F}	Weight
	Length	After break	(kN)	
MO-52020	1.5	3	≥ 22	1.1
MO-52021	2	3.5	≥ 22	1.2

BENEFITS

- 2 steel snap 54 mm opening carabiners with automatic locking.
- Strap adjuster.
- 1 steel snap hook with screwing locking.
- Energy absorber.



ADJUSTABLE LANYARD WITH ENERGY ABSORBER

EN 355
CE

Fall protection function.

Reference	↔	→	kg
	(m)	\vec{F}	Weight
		(kN)	
MO-54020	1.5 m of straps	≥ 22 kN	1.5

BENEFITS

- Energy absorber.
- Automatic hook carabiner.





FORKED LANYARD WITH ENERGY ABSORBER

Fall protection function.

Reference				
	(m)	(m)	(kN)	kg
MO-54010	1.2 m of straps	3	≥ 22	1.4

BENEFITS

- 2 steel snap carabiners with automatic locking.
- 1 steel snap carabiner with screwing locking.
- Double tether rope with energy absorber.



EN 355



SAFETY ROPE WITH SPLICED EYE

Safety rope, 100% polyester made of 3 white strands with black central thread.

Reference				
	(m)	(mm)	(kN)	kg
MO-052	4	15	≥ 22	0.8

BENEFITS

- Static rope with wear indicator.
- Spliced eye with plastic reinforcement.



EN 354



LANYARD

Reference				
	(m)	(mm)	(kN)	kg
MO-053	1.5	10	≥ 22	0.2

BENEFITS

- Synthetic fibre ropes.
- Loops spliced at both ends.



EN 354





DOUBLE SAFETY DESCENDER DEVICE

Double safety manual descender. For 11 mm static rope. Ergonomic shape to improve the self-adjusting descent.

Reference	∅ Lanyard	kg
	(mm)	Weight
MD-02	11	0.4

BENEFITS

- Stainless steel piece.
- High-resistance handle. Anti-panic and anti-faint (auto-locking).



EN 341-A
CE

ASCENSION BLOCKER

Over-moulded ergonomic handle.

Reference	Compatibility	kg
		Weight
MD-03	11 mm semi or static rope	0.2

BENEFITS

- Light alloy.
- Blocking the rope by retractable trigger.



EN 567
CE



OVAL CARABINER

Reference	Opening	\vec{F}		
	(mm)	(kN)	(mm)	Weight
MO-54	18	20	100 x 58	0.154

BENEFITS

- Safety lock with threaded nut.



EN 362
CE



CLIMBERS FOR STEEL POLES

For IPN, H ou L shaped poles.

Reference	Opening	
	(mm)	Weight
MO-23	5 to 20	5.1
Delivered by pair.		

BENEFITS

- Hard forged steel.





SECURITY INSULATING LADDERS

Work on or near electrical installation up to 1 000 V AC or 1 500 V DC.

NF 930-03/01/01-29 L.N.E / N-131 compliant.

A complete range with high specifications:

- Nominal insulation between 2 ring after immersion in water: 10 000 V (EN 50528).
- High mechanical resistance to bending and torsion.
- Good strength / weight ratio.
- Marking of information for use.
- High resistance to weather, corrosive elements and fire.
- Maximum working load 150 daN.



INSULATING LADDERS

Come with right horizontal stabilizer.

Single section ladders

Reference	↕(m)	Numbers of rungs	kg
	Height		Weight
MP-602-D	2.41	8	6
MP-603-D	2.97	10	9
MP-604-D	4.09	14	10
MP-605-D	4.93	17	12

Two section extension ladders

Reference	↔(m)	↔(m)	kg
	Folded	Extended	Weight
MP-624/2-D	2.41	4.09	14.9
MP-634/2-D	2.70	4.65	17

Optional accessories:

Cradle support post and front wheel MP-46503.



Tested 30 000 V / 1 minute EN 50528



BENEFITS

- For LV live working.
- Lateral stiles risers in polyester/ glass fiber rectangular cross section 70 x 25 mm. Aluminium alloy rungs with square cross section.
- 29 x 29 mm ring with anti-slip coating.

INSULATING SLIDE LADDERS

Approval EDF/SPS N° B 216 - 0 - 635.

2 section extension ladders, hand operated

Reference	↔ (m)	↔ (m)	Number of rungs	kg
	Folded	Extended		Weight
MP-514/2	2.41	4.09	2 x 8	13.9
MP-515/2R	2.97	5.21	2 x 10	17

Ladders come with cradle, strap and front wheels.

3 section extension ladders, rope and pulley operated

Reference	↔ (m)	↔ (m)	Number of rungs	kg
	Folded	Extended		Weight
MP-506/2	3.53	6.05	2 x 12	22.9
MP-508/2	4.66	8.30	2 x 16	35.4
MP-509/2	5.22	9.14	2 x 18	39.3
MP-510/2	5.78	10.26	2 x 20	43

Ladders come with cradle, strap and front wheels.

BENEFITS

- For live working LV.
- Lateral stiles risers in polyester/ glass fiber rectangular cross section 70 x 25 mm. Aluminium alloy rungs with square.
- Wheels + cradle.
- 29 x 29 mm cross section anti-slip coating.



EN 50528



MP-506/2



MP-514/2



STANDARD EXTENSION LADDERS

Ladders for electrical work at height. Maximum load: 150 daN. Anti-slip aluminum rungs.

NF EN 131-1
NF EN 131-2
NF EN 131-3

Two section extension ladders, rope and pulley operated

Reference	↔ (m)	↔ (m)	Number of rungs	kg
	Folded	Extended		Weight
MP-607/2-I	4.66	8.02	2 x 16	30.2
MP-608/2-I	5.22	9.14	2 x 18	34.4
MP-609/2-I	5.78	9.98	2 x 20	37.8

Ladders delivered with front wheels

Two section extension ladders, rope and pulley operated

Reference	↔ (m)	↔ (m)	Number of rungs	kg
	Folded	Extended		Weight
MP-607/3-I	2.98	6.89	3 x 10	24.6
MP-608/3-I	3.82	8.86	3 x 13	34.6

Ladders delivered with front wheels

Optional accessories:

Cradle with straps.



MP-607/2-I

MP-608/3-I

BENEFITS

- Upper element lateral stiles risers in polyester/ glass fiber.
- Lower element in aluminium alloy.
- Insulation polyamide pads.



LADDER STABILIZING COMPENSATOR

Compensates for differences in height between the two ladder stiles.

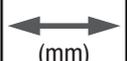
Reference	 (mm)	 (mm)	Spacing (cm)	For ladders	 Weight
	Maximum correction	Length			Weight
MP-46500	30	50 to 70	39 to 44	MP-602-D • MP-603-D MP-604-D • MP-605-D MP-506/2 • MP-514/2 MP-515/2	4.4
MP-46501	35	75 to 95	42 to 47	MP-508/2 • MP-509/2 MP-510/2	4.7



BENEFITS

- Safe setting lever with lock and unlock positions.

INSULATING STEPLADDERS

Compact stepladders with insulating stiles of reinforced polyester fiberglass with light alloy steps to work at height. Insulation between two steps: 30 000 V. Maximum load: 150 daN. Anti-pinch finger hinges.

Reference	Nbr of steps	Height Access (m)	Height folded (m)	Height lower step (m)	Spacing open (m)	 Weight
						Weight
MP-700-4	3	2.58	1.39	0.68	0.75	5.9
MP-700-1	4	2.81	1.64	0.91	0.91	6.9
MP-700-2	5	3.04	1.89	1.14	1.07	8
MP-700-3	6	3.27	2.14	1.37	1.24	9.4
MP-700-5	7	3.50	2.39	1.60	1.40	11

Optional accessories:

Replacement kit anti slip pads MP 700-100.
Replacement Kit toolholders MP 700-200.

BENEFITS

- Railing fitted with a toolholder (height 600 mm).
- Slimline 8.8 cm.
- Wide stiles uprights.

EN 131



MP-700-2



ACCESSORIES FOR INSULATING STEPLADDERS

Reference	 (mm)	
	Dimensions	Weight
MP 700-100	150 x 150 x 60	0.1
MP 700-200	280 x 150 x 100	0.2



FOLDING STEPLADDER WITH SECURED RAILING

Reference	Nbr of steps	Height Access (m)	Height folded (m)	Height lower step (m)	
					Weight
MP-700-I1	3	2.7	2.07	0.7	22
MP-700-I2	4	2.95	2.3	0.95	29
MP-700-I3	5	3.2	2.55	1.17	31



PIRL NFP 93353
EN 50528

BENEFITS

- Nominal insulation between 2 rings: 10,000 V AC (EN 50528).
- Safe railing.
- Tool holder shelf.
- Casters for easy movement.





STACKABLE LADDER ELEMENTS

Metallic elements: NF C 18-430. Stiles upright duralinox. Insulation elements: IEC-61478 Class I. Glass-epoxy – non-slip bars, Orange color. Suitable for LV-MV live working.

Reference	Element type	↔ (m)	Nbr steps	kg
				Weight
MP-402-MB	Metallic base *	2.10	7	5.4
MP-403-MB		3	10	7.6
MP-402-MI	Metallic intermediate.	2.10	7	4.8
MP-403-MI		3	10	7
MP-501-D	Insulating upper element LV/MV	1.20	4	3.3
MP-502-D		2.10	7	5.8
MP-503-D		3	10	8.3

*Telescopic Feet.

Accessories - Spare parts

Reference	Characteristics
MP-400	Set of 2 straps without screws
MP-400-2	Cradle spare



BENEFITS

- Safe assembly with the aluminum connectors.
- Cradles with straps on each element.

TELESCOPIC MEASURING STICKS

Measuring sticks for the height of overhead conductor. Live-line measurements may be performed according to UTE 18-510 recommendations.

Reference	Characteristics
MO-831	Model LV-MV - EDF SPS Approval 18-132 A Max. 11 m - Length folded 1.5 m Usable on a 50 kV network - 3.3 kg
MO-832	Model HV - Max. 12 m Used on LV, MV and HV systems up to 220 kV Identical to other MO-831 features 2 live line elements
M-95-236	Gauge (diameter 3-20 mm)



BENEFITS

- 8 telescopic sections of insulating polyester fiber glass reinforced and operated by a push-button mechanism
- Upper portion made of IEC 60855 orange reinforced synthetic tube.
- Direct reading at the top of the 1st section of the stick, from 2.65 to 11 or 12 m. Graduation in m, dm and cm.



COLLECTIVE PROTECTIVE EQUIPMENT COVER-UP EQUIPMENT

INSULATOR COVER

SERECT Live working LV N°435 specification. For LV insulator.
Synthetic rubber, orange.

Reference	Characteristics			
		(mm)	(mm)	Weight
MP-22	Line insulator	H 150	110	0.47
MP-23	Dead end insulator	H 210	180	1.1



BAG FOR INSULATOR COVER

Steel suspension hook. Reinforced bottom and rope handle.

Reference		
	(mm)	Weight
MP-50	Ø 300 x H 400	0.65



BENEFITS

- Strong and waterproof.

FLEXIBLE - TYPE CONDUCTOR COVER

SERECT Live working LV N°440 specification. For LV conductors.
Shape type Ω, thickness 3.3 mm. For conductor Ø 16 mm max.

Reference		
	(m)	Weight
MP-32/10	1	0.4
MP-32/15	1.5	0.6
MP-33	3	1.2



1 000 V - AC
1 500 V - DC



FLEXIBLE - TYPE CONDUCTOR COVER

SERECT Live working LV N°445 specification. For overhead network (< 1000 V). For conductor Ø 20-22 mm.

Reference	Characteristics	
		Weight
MP-31	Spiral shape type 5 m	0.6
MP-59	Indent tool for MP-31	0.18

1 000 V - AC
1 500 V - DC





INSULATING CAPS

Suitable for overhead, underground and indoor installations at low voltage. Maximum voltage use: 1000 V AC – 1500 V DC. The caps are used for temporary insulation of conductor cable extremities. They must be put in place on the stripped cable end to cover the cable outer insulating sheath.



C18-425 
1000 V - Class 0
DIN VDE 0680-1

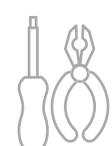

Reference			Capacity on single core cable			
	Caps dimensions		\varnothing of the cable outer sheath to cover (mm) Core cable cross-section (mm ²)			
	Length (mm)	\varnothing Internal (mm)	\varnothing Min (mm)	Cross-section mm ²	\varnothing Max (mm)	Cross-section mm ²
MP-635/10-D	75	10	5	6	9	25
MP-635/15-D	100	15	7	10	13	50
MP-635/20-D	100	20	9	25	16	95
MP-635/25-D	110	25	12	50	20	150
MP-635/30-D	120	30	14	70	25	240
MP-635/40-D	135	40	16	95	30	300
MP-635/50-D	155	50	20	150	40	600
MP-635/60-D	140	60	25	240	50	1000

BENEFITS

- Orange semi-rigid insulating material with blind slot.
- Cross opening for mounting on cable.
- Maintaining in working position by adhesion.





COLLECTIVE PROTECTIVE EQUIPMENT COVER-UP EQUIPMENT INSULATING BLANKETS

ELECTRICAL INSULATING BLANKETS

The electrical insulating blanket is used for the protection for the workers protection from inadvertent contact with live or earthed electrical conductors, apparatus or circuits and to prevent from short circuits on electrical installations.



ELECTRICAL INSULATING BLANKETS IN ACCORDANCE WITH IEC 61112: 2009 STANDARD

According to class 0 specifications. Operating voltage: 1000 V AC and 1500 V DC. In accordance with specific properties:

Category A: acid resistant.

Category C: resistant to very low temperature (-40°C).

Category H: oil resistant.

ACCESSORIES SEE PAGE 65 AND 66

Clamps and adhesive tapes.

MP-41530



MP-41A70/4



MP-18/LOT



MP-19-LOT



RECOMMENDATIONS FOR USE

Storage/Transport

Insulated blankets should be properly stored to avoid the risk of damage to the insulating material. Do not store or use close to excessive heat. Do not expose to direct sunlight for long period. Storage temperature: 10°C to 21°C.

Before use

Insulating blanket cut from a roll should keep visible markings. Each side of the blanket should be visually inspected by the user. The insulating blanket must not have tears or holes. If the blanket is dirty, wash it with soap and water. Dry it with respect of operating temperatures.

In use

Operating temperatures: -40°C to +55°C. Avoid contact with chemical products. Do not walk on the insulating blankets.

Periodic inspection

Insulating blanket should not be used without having been electrically tested within the previous twelve months preceding with the exception of class 00 and 0. Only visual inspection is required for class 00 and 0.



INSULATING FLEXIBLE BLANKETS

Polyvinyl in roll. IEC 61112 – class 0

Reference	Class					
		Voltage (AC)	Voltage (DC)	Dim. (m)	Thickness (mm)	Weight (kg)
MP-35	0	≤ 1 000 V	≤ 1 500 V	1.3 x 25	0.3	12
MP-35/12	0	≤ 1 000 V	≤ 1 500 V	1.3 x 12.5	0.3	6
MP-37	0	≤ 1 000 V	≤ 1 500 V	0.09 x 25	0.3	0.8

In accordance with ST HTA 50D EDF-SERECT specification.

Reference	Class			
		Dimensions (m)	Thickness (mm)	Weight (kg)
MP-40	0	1.3 x 25	0.8	24

BENEFITS

- Flexible translucent polyvinyl.
- Fastening with clamps, adhesive tape or magnet patches.

IEC/EN 61112

MP-37



MP-35
MP-40



INSULATING FLEXIBLE BLANKETS OF ORANGE RUBBER

Reference	Class					
		Voltage (AC)	Voltage (DC)	Dim. (m)	Thickness (mm)	Weight (kg)
MP-220	0	≤ 1 000 V	≤ 1 500 V	1 x 1	1	1.5
MP-220/1	0	≤ 1 000 V	≤ 1 500 V	1 x 10	1	15

BENEFITS

- High resistance to perforation.
- Special properties : resistant to low temperatures (C) and oil (H).

IEC/EN 61112



INSULATED MAGNETS FOR BLANKETS

Marking on each product with 2D code for traceability.
Magnetic strength: 8 kg.

Reference	Class					
		Voltage (AC)	Voltage (DC)	Dim. (mm)	Weight (g)	Set
MP-41A70/4	0	≤ 1 000 V	≤ 1 500 V	Ø70 x 5	35	4

NEW

IEC/EN 61112



x 4

BENEFITS

- Hole to hang a tool or a device.
- Rubber insulating material with special properties.



COLLECTIVE PROTECTIVE EQUIPMENT COVER-UP EQUIPMENT

INSULATING FLEXIBLE BLANKETS

Individual model made of reinforced polyvinyl.

Reference	Class					
		Voltage (AC)	Voltage (DC)	Dim. (mm)	Thickness (mm)	Weight (kg)
MP-123	0	< 1 000 V	< 1 500 V	360 x 660	0.5	0.15
MP-123/1	0	< 1 000 V	< 1 500 V	500 x 900	0.5	0.3
MP-123/2	0	< 1 000 V	< 1 500 V	800 x 1200	0.5	0.6

BENEFITS

- Translucid polyvinyl. Reinforced by synthetic fibre mesh.
- The "Velcro®" fastener type allows the flexible blankets to seal off by pressing the edges together. Several flexible blankets can also be connected in this manner.

BLANKET CLAMPS

Reference			
	Length (mm)	Set	Weight (g)
MP-4110	160	1	60
MP-41530	65	12	10

BENEFITS

- Bimaterial insulating clamps (MP-41530).

Reference			
	Length (mm)	Set	Weight (g)
MP-625-D	160	1	70
MP-627-D	80	3	30

BENEFITS

- Fully insulating clamps.

ELECTRICAL ADHESIVE TAPES

High quality electrical insulation tape, self-extinguishing.

Reference	Characteristics		
		Dim. (m)	Set
MP-18-LOT	Phases marking tape	0.015 x 10	4 rolls*
MP-19/LOT	Coloured marking tape	0.015 x 10	10 rolls**

* Phases = L1, L2, L3 (black) and neutral = N (blue).

** green/yellow, orange, yellow, brown, red, blue, white, black, grey, green.



IEC/EN 61112



ST TST BT N°415
Class 0



MP-4110



MP-41530



DIN VDE 0680-1
Class 0 - 1 000 V



MP-625-D



MP-627-D



MP-19-LOT



MP-18/LOT

EN 60454



LOCKOUT TAGOUT

SAFETY PADLOCKS	69
PADLOCK CARRIERS AND STATION	72
MULTIPLES HASPS	73
CIRCUIT BREAKER LOCKOUT	75
BUTTON COVER.....	79
VALVE LOCKOUTS	80
LoTo STATION AND CABINETS.....	82
LOCKOUT KITS	84



LOCKING, AN ESSENTIAL STAGE FOR LOCKOUT

Depending on the environments, default lockout accidents are caused by the:

- Continued presence of live conductor parts for electrical installations.
- Presence of pressurized fluids (hydraulic circuits).
- Presence of unstable mechanical systems.

The corresponding recommendations must be applied for each risk, but in all cases specific locking with regard to the risk considered must be set up.

Sometimes the overall analysis of risks reveals a combination of the different risks which makes a more extensive locking operation mandatory. This is especially the case with electricity production equipment.

What does locking mean?

The purpose of locking is to separate cut off or neutralisation parts with a suitable, and sufficiently protected system to prevent any operation by unauthorised persons (switching on power for an electrical installation).

Locking is generally accompanied by signs. For the electrical domain, setting up and removing the lockout are described in national and European standards (EN 50110-1).

For electricity production equipment: more generally, the safety recommendations are included in Directive 2009/104/EC on the minimum health and safety recommendations for using work equipment.



Lock-out Tag-out or LoTo

The OSHA 1910.147 for «The control of hazardous energy (lockout/tagout)» offers procedures and minimum requirements for a safe work for the control of such hazardous energy. The standard «covers the servicing and maintenance of machines and equipment in which the unexpected energization or start up of the machines or equipment, or release of stored energy, could harm employees.»

Lock-out : to secure or block the machine or equipment from energy sources.

Tag-out : to warn the others to not use this machine or this equipment without authorization of the authorized person responsible for it.

BENEFITS

- Anti-corrosion brass shackle.
- Marking on both surfaces: standardized symbol/operator identity.
- All padlocks are supplied with 2 keys.

SPECIAL MODELS WITH PICTOGRAMS

Reference	↑ (mm)	∅ (mm)	Colour	
	Shackle			Weight
AL-230-(**)-EX	50	6		204
AL-230-S-(**)-EX	70	6		214
AL-230-Z-EX	50	6		204
AL-230-S-Z-EX	70	6		214
AL-240-(**)-EX	50	4		192
AL-240-00-EX	50	4		192
AL-240-S-(**)-EX	70	4		198
AL-240-S-00-EX	70	4		198
AL-240-Z-EX	50	4		192
AL-240-S-Z-EX	70	4		198

00: Key number on request. (**) Add key number: 111 or 222. Z : key different.



COLOUR MODELS WITH PICTOGRAMS

Reference	↑ (mm)	∅ (mm)	Colour	
	Shackle			Weight
AL-240-B-111-EX	50	4		192
AL-240-B-Z-EX	50	4		192
AL-240-B-00-EX	50	4		192
AL-240-S-B-111-EX	70	4		198
AL-240-S-B-00-EX	70	4		198
AL-240-J-111-EX	50	4		192
AL-240-J-Z-EX	50	4		192
AL-240-J-00-EX	50	4		192
AL-240-S-J-111-EX	70	4		198
AL-240-S-J-00-EX	70	4		198
AL-240-BL-111-EX	50	4		192
AL-240-BL-Z-EX	50	4		192
AL-240-BL-00-EX	50	4		192
AL-240-S-BL-111-EX	70	4		198
AL-240-S-BL-00-EX	70	4		198
AL-240-V-111-EX	50	4		192
AL-240-V-Z-EX	50	4		192
AL-240-V-00-EX	50	4		192
AL-240-S-V-111-EX	70	4		198
AL-240-S-V-00-EX	70	4		198



RED MODELS WITH INSULATED SHACKLE

Shackle covered with insulating red PVC. Insulation: 1000 V AC.

Reference	↑ (mm)	∅ (mm)	Colour	
	Shackle			Weight
AL-260-(**)-EX	50	6.2		200
AL-260-00-EX	50	6.2		200
AL-260-Z-EX	50	6.2		200
AL-260-S-(**)-EX	70	6.2		210
AL-260-S-00-EX	70	6.2		210
AL-260-S-Z-EX	70	6.2		210

00: Key number on request. (**) Add the key numbers 111 or 222 only.



For any additional key, order the reference A-76230 and specify the key number of the required key. Applies to all CATU padlocks.





SAFETY PADLOCKS

CHOOSE YOUR PADLOCKS!

A COMPLETE RANGE OF PADLOCKS TO MEET ALL OF YOUR NEEDS

∅ (mm)			↕ (mm)		Body colours					Keys			Stickers
Shackle diameter			Shackle length										
6,2	4	6	50	70	Red	White	Yellow	Blue	Green	Standard	Random	Upon request	Picto
AL-260	AL-240	AL-230	-	S	-	B	J	BL	V	(*) (**)	Z	00	-

Shackle covered

TO ORDER YOUR PADLOCKS

Bill of material as a reference for your padlocks:

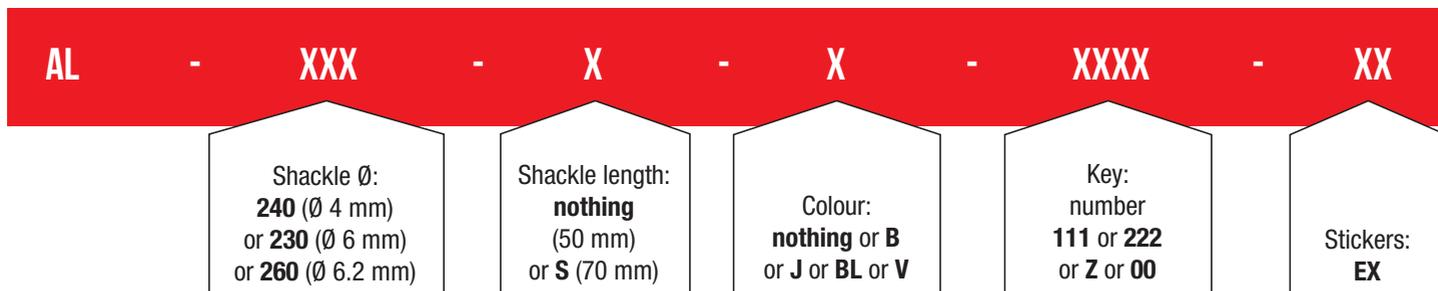

1st example:

Insulated shackle ∅ 6.2 mm **AL-260**
 Shackle Lg 50 mm -
 Standard colour (red) -
 Key n°222 **222**
 Sticker with picto **EX**
 Your reference: **AL-260-222-EX**



2nd example:

Shackle ∅ 4 mm **AL-240**
 Shackle Lg 70 mm **S**
 Colour blue **BL**
 Key upon request **00**
 Sticker with picto **EX**
 Your reference: **AL-240-S-BL-00-EX**



CODES FOR KEY NUMBERS

(**): Add key number: 111 or 222.
 Z: Different key number (at random).
 00: Key number on request.



TABLES OF POSSIBLE COMBINATIONS

Key	Sticker	AL-240 (Ø 4 mm)					AL-260 (Ø 6,2 mm insulated shackle)					AL-230 (Ø 6 mm)	
		- (Shackle 50 mm)					- S (Shackle 70 mm)					- (Shackle 50 mm)	- S (Shackle 70 mm)
		-	B	J	BL	V	-	B	J	BL	V	-	-
(**)		•	•	•	•	•	•	•	•	•	•	•	•
Z		•	•	•	•	•						•	•
00		•	•	•	•	•	•	•	•	•	•		

• Existing padlocks.



PRESEL PADLOCKS WITH INSULATING SHACKLE



Small and lightweight: easy to carry. Insulated: non-conductive body and nylon shackle.

Reference	Key	↑ (mm)	∅ (mm)	Colour	
PP-6-38-R-*	Alike	38	6	Red	60
PP-6-38-R-Z	Different	38	6	Red	60
PP-4-38-R-*	Alike	38	4	Red	60
PP-4-38-R-Z	Different	38	4	Red	60
PP-4-38-B-Z	Different	38	4	Blue	60
PP-4-38-Y-Z	Different	38	4	Yellow	60
PP-4-38-G-Z	Different	38	4	Green	60
PP-4-38-BK-Z	Different	38	4	Black	60
PP-4-38-W-Z	Different	38	4	White	60
MK-A15-PPM638	Master key for key alike A1, A2, A3, A4 and A5				

* Add the key number for key alike: A1, A2, A3, A4 or A5.



Unique 4 mm diameter insulating shackle.



PADLOCK CARRIERS AND STATION

YELLOW PADLOCK AND TAG CARRIER

Fitted to the belt so as to free up the hands. Key ring incorporated into the handle. Label system ensures that the user knows that all the power sources have been locked out.

Reference		∅ (mm)	 (mm)	
		Holes	Dim.	Weight
AL-212	12	9	190 x 130	120



BENEFITS

- Can be hand-carried or be worn on a belt.
- Holds up to 12 padlocks.

IVORY PADLOCK CARRIER

Ivory white PVC. High resistance to impacts. Holds up to 30 padlocks.

Reference		∅ (mm)	 (mm)	
		Holes	Dim.	Weight
AL-207/30	30	9	405 x 150	130



CARRIER FOR LOCKOUT MANAGER' MODEL

Handle dimensions 156 x 73 x 12 mm.

Reference		
		Weight
AL-206	0 (Handle only)	0.15
AL-236-111-EX	6 (AL-230-111-EX)	1.15
AL-236-222-EX	6 (AL-230-222-EX)	1.15
AL-236-S-111-EX	6 (AL-230-S-111-EX)	1.21
AL-236-S-222-EX	6 (AL-230-S-222-EX)	1.21
AL-236-00-EX*	6 (AL-230-00-EX)	1.15
AL-236-S-00-EX*	6 (AL-230-S-00-EX)	1.21

*00: key number on request.



BENEFITS

- Compartment with transparent cover for key storage.
- Plastic handle with 6 padlocks keyed alike.



WALL STATION FOR PADLOCKS

Red-painted metal wall station. Fixation hole.

Reference			
		(mm)	
		Dim.	Weight
RL-100	12	175 x 71 x 31	665



FLEXIBLE INSULATING HASPS

Nylon (non-conductive). Warning label "Danger" and identification of the person carrying out the work.

Reference					
	(mm)		(mm)	(mm)	
		Shackle	Holes	Length	Weight
ALP-03	50	3	9	105	20
ALP-06	80	6	9	183	30



ALP-06



ALP-03



ALL-PLASTIC INSULATING HASPS

Label with 'DANGER' warning and identification of the person carrying out the work.

Reference						
	(mm)	(mm)		(mm)	(mm)	
		Shackle	Holes	Length	Weight	
ALP-4/3	46	3	4	8	108	35
ALP-4/6	46	6	4	8	108	35



ALP-4/6



ALP-4/3



UNIVERSAL MODEL

Steel cable coated with non-conductive PVC.

Reference				
	(mm x m)		(mm)	
		Cable	Holes	Weight
ALP-12/2M	Ø4 Lg 2m	12	9	130
ALP-12/5M	Ø4 Lg 5m	12	9	160



BENEFITS

- Steel cable coated with non-conductive PVC.
- Holds up to 9 padlocks. Nylon body.



MULTIPLE HASPS

METALLIC HASPS

Made of anti-corrosion metal. Holds up to 4 padlocks of \varnothing 6 mm max (AL-203, AL-230 or AL-240).

Reference	Description	 (mm)	
		Dim.	Weight
AL-200	Enedis type A	100 x 60 x 10	150
AL-202	Enedis type B	165 x 50 x 12	200

Safety padlock

Reference	\varnothing (mm)	\updownarrow (mm)	
	Shackle		Weight
AL-203*	6	50	180

*Key n° 111

BENEFITS

- Allows hanging a prohibition disk.



AL-200



AL-202



AL-203



Example of use of AL-202

RED METALLIC HASPS

Made of high-resistance steel.

Reference	\varnothing (mm)		\varnothing (mm)	\longleftrightarrow (mm)	
	Clamping		Holes	Length	Weight
ALM-6/25	25	6	9	112	95
ALM-6/38	38	6	9	125	110
ALM-20/45	20 & 45	6	9	138	120

BENEFITS

- ALM-20/45: double sided.
- ALM-6/...: Red coated metallic hasps.



ALM-6/25



ALM-6/38



ALM-20/45

STEEL SHACKLE HASPS

Label with 'DANGER' warning and identification of the person carrying out the work. High-strength steel shackle and body.

Reference	\updownarrow (mm)	\varnothing (mm)	\varnothing (mm)	\longleftrightarrow (mm)	
	Shackle		Holes	Length	Weight
ALM-6/8	25	5	8	115	80



MONOBLOC PLASTIC SEAL

Red plastic. Patented mechanism: anti-intrusion system ensuring security of the system.

Reference	↔ (mm)	↔ (mm)
	Body	Tie
AL-145R/200	Ø 15 x 7	135

Set of 200 pieces.

BENEFITS

- Patented mechanism: anti-intrusion system.
- Possibility of inserting the tie by the left or the right into the closable part.

MICRO-CABLE LOCKOUT

Red plastic body. Vinyl coated steel cable.
Sticker with «DANGER» pictograms and user identification

Reference	∅ (mm)	↔ (mm)	📖 g
	Body	Rod	Weight
AL-220	61 x 37 x 15	Ø 2 x L 200	30

BENEFITS

- Can accept up to 2 padlocks (Ø 6 mm and Ø 8 mm max).
- Suitable for limited area with a locking hole under 4 mm.

CLIPBLOCK™ COMPACT CIRCUIT BREAKER LOCKOUT

Quick fitting with a no. 3 flat screwdriver. Highly compact and can be locked. "DO NOT OPERATE" sign. Delivered in pack.

Reference	📦	📖 g
	Description and set	Weight
AL-201/1	5 units, no padlock	158
AL-201-C/1	Delivered with 1 padlock *	60
AL-216	Padlock* only, steel shackle Ø 3 mm	16

* Key different.

BENEFITS

- Compatible with most brands of modular circuit breakers, switches and differentials.





CIRCUIT BREAKER LOCKOUTS

MULTIPLE INSULATING LOCKOUT

Suitable for all types of low voltage protection unit locker. Particularly suited to the CLIPBLOCK™ circuit breaker locker. High resistance plastic cord. Length 2 m or 5 m. ABS body for use with Ø 4 to 6 mm padlocks.

Reference			Holes	
	Description and set		(mm)	
AL-205	Supplied with 2 m PVC cord	3	6	110
AL-205/5	Supplied with 5 m PVC cord	3	6	160

BENEFITS

- Cable with plastic stopper to use in loop or single cord.
- Allows to lock-out remotely in case of lack of space.
- Suitable for all types of low voltage protection unit locker. Particularly designed to be used with circuit breaker locker CLIPBLOCK™.



MEDIUM-SIZE CIRCUIT BREAKER LOCKOUTS

Red plastic. No tool needed for installation (tightened manually).

Reference	Ø	Screw		
	(mm)		Dim.	
AL-208-C *	8	Stainless steel	52 x 25	20
AL-208-D **	8	Stainless steel	52 x 33	20

* Bent snipe nose. ** Straight.

BENEFITS

- No tools needed for installation (tightened manually).



CIRCUIT BREAKER LOCKOUT "SLIDE & PIN"

Plastic body.

Reference		Ø		
		(mm)	Dim.	
AL-210	1	7	41 x 23 x 23*	6

* Closed.

BENEFITS

- Fits with most of circuits breakers.
- Easy installation and without tools: just slide and pin.



LARGE CIRCUIT BREAKER LOCKOUT

No tool needed for installation. Turn the screw to tighten the circuit breaker handle and lock with one or more padlocks and a warning tag.

Reference		∅ (mm)	 (mm)	 (mm)	
		Holes	For levers	Dim.	Weight
AL-209-L	12	8	76 x 23	105 x 95	66

BENEFITS

- Easy installation without tools.
- 12 holes diameter 8 mm, suitable for 3 hasps or padlocks locked at the same time.



LOCKOUT MODEL FOR MOULDED UNITS

Suitable for Schneider circuit breakers with the following references: NS80, NSE75/NSE100, NS100/NS160/NS250, NSF150/NSF250, NS400/NS630, NSJ400/NSJ600.

Reference		∅ (mm)	 (mm)	
		Holes	Dim.	Weight
AL-204	3	8	37 x 49 x 4*	32

* Closed.



TAG-OUT BADGES

∅ 10 mm hole on the upper part for attachment.

Reference	 (mm)	Type
	Dim.	
AM-467-GB	∅ 80	Aluminium
AP-499/1	∅ 100	Plastic
AP-460*	120 x 70	Flexible plastic

*set of 10 badges



AM-467-GB



AP-460



AP-499/1





CIRCUIT BREAKER AND ELECTRICAL LOCKOUT

ELECTRICAL AND PNEUMATIC PLUG LOCKOUTS

Polystyrene. Electrical and pneumatic socket locker device. Easy to install with the two articulated parts. Padlock locking.

Reference	🔒	∅ (mm)	□ (mm)	□ (mm)	📏 g
		Holes	For cable	Dim.	
PL-100	2	9	∅ 12	88 x 50 x 50	56
PL-101	4	9	∅ 25	171 x 83 x 83	211



PL-100



PL-101

BENEFITS

- Holds up to 4 padlock.

OVERSIZED PLUG AND HOIST CONTROL LOCKOUT

Red fabric and black leather. Locking device for the control units of numerical machines, cranes, winches, overhead cranes. Padlock locking.

Reference	🔒	∅ (mm)	□ (mm)	📏 g
		Holes	Dim.	
PL-102	6	11	460 x 210	65



BENEFITS

- Holds up to 6 padlock.

INDUSTRIAL SINGLE OR MULTIPHASE PLUG LOCKOUT

Plastic body. Suitable for male part of the plug.

Reference	🔒	∅ (mm)	□ (mm)	📏 g
		Holes	Dim.	
PL-103	1	8	55 x 37 x 27	14



PL-103

BENEFITS

- Suitable for most industrial plugs from 16 to 125 A.
- Fast and easy to install.

BUTTON COVERS

Enable to prevent access to switch or control button and to avoid an untimely switch back on of the equipment. To clip between removable button and surface or stick directly on the surface for fixed button.
Made of resistant polycarbonate.

Possibility to replace the adhesive part if necessary:
- Set of 5 adhesives AL-211/15 for the cover AL-211/1
- Set of 5 adhesives AL-211/25 for the cover AL-211/2



Part number	Button			Cover			
	 Ø max (mm) (widest part of the button)	 Height max (mm)	 Ø max (mm)		Hole for padlock (mm)	Opening (mm)	 (mm) Dim.
AL-211/1	Removable button: 40 mm Fixed button: 20 mm	23	22	1	7	22	Ø 50. H 32
AL-211/2	Removable button: 40 mm Fixed button: 28 mm	23	30	1	7	30	Ø 50. H 32

BENEFITS

- Allows you to block access to standard control devices push buttons or rotary buttons.
- Thanks to the adhesive support, the covers can also be used for non-removable buttons.

UNIVERSAL BUTTON COVER

Enable to prevent access to switch or control button and to avoid an untimely switch back on of the equipment. Suitable for a lot of button, even rotary button with key.
Made of resistant polycarbonate.

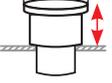
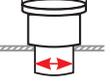

Part number	Bouton			Capot			
	 Ø max (mm) (widest part of the button)	 Height max (mm)	 Ø max (mm)		Hole for padlock (mm)	Opening (mm)	 (mm) Dim.
AL-214	Removable button: 50 mm Fixed button: 42 mm	40	22 30	1	7	45	Ø 60. H 50

BENEFITS

- Transparent bases for reading labels.
- A circular plastic base adjustable to a diameter of 22 mm (use as is) or 30 mm (remove the teeth with pliers).
- A semi-circular base to use for more difficult accesses (presence of a nameplate for example).





VALVE LOCKOUTS

ROTATING GATE VALVE LOCKOUTS

Polyurethane. Easy to install with the two articulated parts*. Padlock locking.

Reference		∅ (mm)	∅ (mm)	∅ (mm)	↕ (mm)	
		Holes	Gate*	Int.	Height	
HL-100	1	10	25 to 63	69	35	69
HL-101	1	10	64 to 127	130	46	211
HL-102	1	10	127 to 165	170	54	336
HL-103	1	10	165 to 254	257	70	670
HL-104	1	10	254 to 330	354	70	1150
HL-105	1**	10	25 to 165	170	53	243

* except HL-105 (2 loose parts). ** over 3 adjustment positions.



BENEFITS

- Prevents any handling of the gate valve.
- HL-105: adjustable model.



QUARTER TURN BALL VALVE LOCKOUTS

Polyurethane. Easy to adjust with the two sliding parts. Padlock locking preventing any ball valve lever activation.

Reference		∅ (mm)	Locking (mm)	↔ (mm)	
		Holes		Length	
HL-200	1/ 8 positions	*	45 to 125	140	155
HL-201	1/ 13 positions	**	50 to 190	254	230
HL-202	1/ 12 positions	***	75 to 215	295	580

* 7 holes 8 positions ** 7 holes 13 positions * 9 holes 12 positions



BENEFITS

- Several adjustment positions for each model.

UNIVERSAL QUARTER TURN BALL VALVE LOCKOUT

Polypropylene. For locking all types of valves: 1/4 turn, butterfly, etc.

Reference			Locking (mm)		
				Length	Weight
HL-203	1 padlock 9 positions	9	95 to 255	300	285

BENEFITS

- Adjustable model.

GAS VALVE LOCKOUT

Polystyrene. Gas bottle lockout (propane, butane, oxygen, etc.).

Reference			Locking (mm)		
				Dim.	Weight
GL-100	1	7	Ø 29	Ø 70	60
GL-101	1	7	Ø 35	Ø 85-L150	135

BENEFITS

- Easy to install with the two articulated parts.

STEERING WHEEL COVER

Ensures perfect steering wheel lockout up to wheel diameter of 42 cm. Transparent pocket to display customized message while in use.

Reference		
	Steering Wheel cover	Weight
ALPV-L-D	Up to diameter 42 cm	150



GL-100

GL-101





FOCUS

EXPERT

LOCK BOX – SL-106

This Group Lockout Box offers more safety during lock-out procedure, especially for teams work who take care of equipment maintenance or repair. The device prevents the untimely unlocking as long as the operator intervention on the installation is not over.

How does it work?

All keys relating to the locked equipment are placed in the lock box. Each authorized work team member places his personal safety padlock on the lock box in one of the slots provided for this purpose on the lid of the box. The lock-out keys of the equipment are inaccessible, it is impossible to unlock the equipment unless the operator work is done and all personal safety padlocks are removed. When the job is completed, operators remove their individual safety padlock from the lock-box. Once of all personal padlocks have been removed, the keys of the locked equipment become accessible for unlocking the facility.



- ❶ 12 available spaces to place the safety padlocks of work team members. If there are more operators, possibility to use hasps.
- ❷ Suitable for both portable and fixed applications thanks to internal quick-release button to lock/unlock to the supplied wall bracket.
- ❸ Key slot to insert a key if other power sources have to be isolated after the maintenance work has started.

LoTo STATION

LoTo station with a capacity of 4 padlocks, 1 hasp and 1 set of tags. Fields to write with your emergency numbers. Composition : 1 LoTo station, 1 set of 30 lockout tags SL-103-100, dowels and screws included.

Reference	 (mm)	 kg
	Dim.	Weight
SL-103-04-01-Y	300 x 265 x 4.5	0.475

LoTo CABINET

Two adjustable shelves (12 positions). Locked by key. Delivered empty with attachment dowels and screws. Optional accessories.

Reference	 (mm)	 kg
	Dim.	Weight
SL-101	405 x 355 x 156	5.6

BENEFITS

- Shelves with rim preventing the fall of objects.
- Versatile: for wall mounting and hand carrying, thanks to an integrated reversible handle.

PADLOCKS CABINET

Locked by key. Delivered with 4-level padlock support, attachment pegs and screws. Optional padlocks.

Reference		 (mm)	 kg
		Dim.	Weight
SL-102	42	465 x 395 x 55	4.5

GROUP LOCK BOX

Painted metal. "PUSH" button opening. Removable handle. Supplied wall bracket to be mounted on the wall with the delivered screws and dowels. Suitable for 12 padlocks or Multiple hasps.

Reference		 (mm)	 kg
		Dim.	Weight
SL-106	12	240 x 174 x 40	1





LOCKOUT KITS

CIRCUIT BREAKER LOCKOUT KIT

Reference	Reference: KIT-CONSI01D-GB	Quantity
AL-201/C1	Small circuit breaker locker with padlock	3
AL-208-D	Medium-size circuit breaker locker	3
AL-209-L	Large-size circuit breaker locker	1
AM-467-GB	Lockout tag	5
M-87290	Storage bag	1



AL-209-L



M-87290



AM-467-GB



AL-208-D



AL-201/C1

GENERAL LOCKOUT KIT

Reference	Reference: KIT-CONSI-01G-GB	Quantity
M-87370	Storage bag	1
AL-240-Z-EX	Padlock with shackle 50 mm and Ø 4 mm, key different	2
ALM-6/25	Hasp	1
ALP-4/6	Multiple locker	1
ALP-12/2M	Universal multiple locker	1
HL-105	Gate valve lockout (Ø 25 to 165 mm)	1
HL-200	Gate valve lockout (locking from 9.5 to 31.75 mm)	1
HL-201	Quarter turn ball valve lockout (locking from 38 to 63.5 mm)	1
AM-467-GB	Lockout tag	10



M-87370



AM-467-GB



ALP-4/6



AL-240-Z



HL-200



HL-201



ALM-6/25



ALP-12/2M



HL-105



ELECTRICAL LoTo KIT

NEW

Reference	Reference: KIT-CONSI-01E	Quantity
PP-4-38-R-Z	Padlock with non-conductive shackle Ø 4 mm, key different	1
M-87292	Storage bag	1
PP-6-38-R-Z	Padlock with non-conductive shackle Ø 6 mm, key different	1
AL-205	Multiple insulating lockout	1
ALM-6/25	Hasp	1
ALP-4/3	Non-conductive plastic hasp	1
AL-201/C1	Compact circuit breaker lockout with padlock	1
AL-208-D	Medium size circuit breaker lockout	2
AL-210	Slide & Pin circuit breaker lockout	2
AL-209-L	Large circuit breaker lockout	1
AP-460	Lockout tag	2



M-87292



ALM-6/25



AL-209-L



AP-460



AL-205



ALP-4/3



AL-201/C1



AL-210



PP-4-38-R-Z



PP-6-38-R-Z



AL-208-D



CUSTOMIZE CATU SAFETY EQUIPMENTS WITH YOUR BRAND

INCREASE THE VISIBILITY OF YOUR BRAND BY
CREATING UNIQUE PRODUCTS WITH YOUR LOGO

SERVICE AVAILABLE FOR :



- Unlimited colours to respect your logo.
- Short lead-time.
- Minimum order quantities : 10 units.

For further information, please contact our customer service:

 service.export@catuelec.com

 Phone: +33 1 42 31 46 08

CATUTM
SICAME GROUP

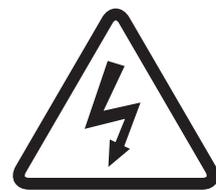

SIGNALLING



WARNING SIGN	88
SIGNALLING AND DELINEATORS	91



WARNING SIGNS

Special tool steel, oil-hardened.

Reference	(mm)	(mm)	Colour
		Dim.	
AM-344-GB	Aluminium	100 mm side	Black letters on yellow
AM-345-GB	Aluminium	100 mm side	Black letters on yellow
AM-344	Aluminium	100 mm side	Black/yellow
AM-344/05	Aluminium	50 mm side	Black/yellow
AM-49/1	Aluminium	100 mm side	Black/yellow
AM-49/2	Aluminium	200 mm side	Black/yellow
AM-41/1	Aluminium	100 mm side	Black/yellow
AM-41/2	Aluminium	200 mm side	Black/yellow
AM-467-GB	Aluminium	Ø 100	White letters on red
AP-499/1	Plastic	Ø 100	White/red
AP-510-BT-GB	Plastic	297 x 210	Low voltage
AM-51/1	Aluminium	100 mm side	Black/yellow
AP-510-GB	Plastic	297 x 210	Medium voltage
AP-460	Soft plastic	120 x 70	White/yellow/black/red



AM-344-GB



AM-345-GB

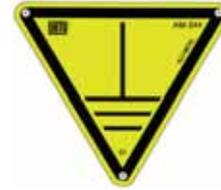

AM-344 - AM-344/05

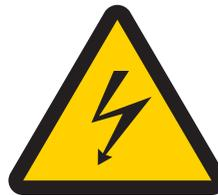

AM-49/...



AM-41/...



AM-51/1



AM-467-GB



AP-499/1



AP-460

DEAD WORKING LOW VOLTAGE GOLDEN RULES

Select the right equipment

- Face shield
- Insulating gloves
- Padlock
- Voltage detector
- Insulating mat or platform
- Short-circuiting system
- Signaling

- 1** Separate the work area from all sources of power supply.
- 2** Lock the circuit breaker in the open position.
- 3** Network identification.
- 4** Check the absence of voltage.
- 5** Apply appropriate short-circuiting and earthing systems.
- 6** Show, warn others and isolate the work area from the close live parts.

In conformity with EN 50110 - NF C 18-510 - Decree n°2010-1118 du 22/09/2010 12 AP-510-BT-GB GATU

AP-510-BT-GB

DEAD LINE WORKING MEDIUM VOLTAGE GOLDEN RULES

Select the right equipment

- Face shield
- Insulating gloves
- Padlocks
- Voltage Detector
- Insulating stick
- Insulating platform or mat
- Short-circuiting & earthing systems
- Signaling

- 1** Separate the work area from all possible sources of power supply.
- 2** Lock the insulation devices in the open position.
- 3** Network identification.
- 4** Check the absence of voltage.
- 5** Apply the appropriate short-circuiting and earthing systems.
- 6** Show, warn others, Protect the work area from the close live parts.

In conformity with EN 50110 - NF C 18-510 - Decree n°2010-1118 du 22/09/2010 13 AP-510-GB GATU

AP-510-GB

SUBSTATION SIGNS

Specialist signs.

Reference	(mm)	(mm)	Colour
		Dim.	
AM-61-GB	Aluminium	200 x 150	Yellow/black and blue letters, on plain aluminium
AM-61-RM	Aluminium	200 x 150	Yellow/black and blue letters, on plain aluminium
AM-282/2-RM	Aluminium	200 x 60	Yellow/black and blue letters, on plain aluminium
AM-32/3	Aluminium	∅ 300	White/red
AM-33/3	Aluminium	∅ 300	Red/black on alu
AM-34/2	Aluminium	∅ 200	Red/black on alu
AP-951/2	Plastic	200 x 200	White/red
AP-510-GB	Plastic	420 x 297	Golden rules
AM-20-RM	Aluminium	297 x 420	Blue letters on plain aluminium
AM-20-GB	Aluminium	297 x 420	Blue letters plain aluminium



AM-61-GB



AM-61-GB



AM-282/2-RM



AM-32/3



AM-33/3



AM-34/2



AP-951/2



AM-20-GB



AM-20-RM

FIXING TOOLS FOR WARNING SIGNS

Reference	Characteristics
AC-21	Small nickelled chain sold in bags of 10 units. Dim 2 x 11 cm
AD-01	Anti-vandalism round-headed screw M3x15 delivered in bags of 100 units.
AC-44	Self-adhesive magnets (∅ 40 mm) for sign mounting (bag of 10 units)



AD-01



AC-44



AC-21





WARNING SIGNS

SELF ADHESIVE WARNING SIGNS

Complete range of self adhesive warning signs packed by of 20, 30 or 50 units.



Reference	 (mm)	
	Dim.	Set
AT-41/025	25 mm side	50
AT-41/05	50 mm side	30
AT-41/1 **	100 mm side	20
AT-49/025	25 mm side	50
AT-49/05 **	50 mm side	30
AT-49/1 **	100 mm side	20
AT-50/025	25 mm side	50
AT-50/053	50 mm side	30
AT-50/1	100 mm side	20
AT-51/025	25 mm side	50
AT-51/05	50 mm side	30
AT-51/1	100 mm side	20
AT-52/05	50 x 25 mm	30
AT-52/1	100 x 50 mm	20
AT-53/05	50 x 25 mm	30
AT-53/1	100 x 50 mm	20
AT-54/05	∅ 50 mm	30
AT-54/1	∅ 100 mm	20
AT-55/05	∅ 50 mm	30
AT-55/1	∅ 100 mm	20
AT-56/05	∅ 50 mm	30
AT-56/1	∅ 100 mm	20
AT-58/05	∅ 50 mm	30
AT-58/1	∅ 100 mm	20
AT-59/05	∅ 50 mm	30
AT-59/1	∅ 100 mm	20
AT-60/05	∅ 50 mm	30
AT-60/1	∅ 100 mm	20
AT-61/05	∅ 50 mm	30
AT-61/1	∅ 100 mm	20
AT-62/05	∅ 50 mm	30
AT-62/1	∅ 100 mm	20
AT-63/05	∅ 50 mm	30
AT-63/1	100 mm side	20
AT-67/1	100 mm side	20
AT-67/05	50 mm side	30
AT-68/05	50 x 25 mm	100
AT-68/1	100 x 50 mm	100

* Available in pack of 500, references : AT-41/1-500, AT-49/1-500 and AT-49/05-500.



AT-41/1



AT-41/05



AT-41/025



AT-52/1



AT-49/1



AT-49/05



AT-49/025



AT-52/05



AT-53/1



AT-50/1



AT-50/053



AT-50/025



AT-53/05



AT-55/1



AT-51/1



AT-51/05



AT-51/025



AT-68/1

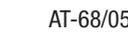

AT-68/05



AT-54/1



AT-54/05



AT-55/1



AT-55/05



AT-56/1



AT-56/05



AT-58/1



AT-58/05



AT-59/1



AT-59/05



AT-60/1



AT-60/05



AT-61/1



AT-61/05



AT-62/1



AT-62/05



AT-63/1



AT-63/05



AT-67/1



AT-67/05

WARNING FLAGS

Brightly coloured ribbon.

Reference	(mm)	Mounting
	Dimensions	
AL-53	350 Width x 650 Height	Hanging by a string



AL-53

GROUNDING FLAGS

Vinyl coated fabric.

Reference	(mm)	Mounting
	Dimensions	
AL-58	338 Base x 365 Height	By flagpole 0.75 m
AL-60	338 Base x 365 Height	Fixing on earthing cable by scratch

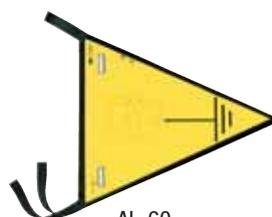

AL-60



AL-58

INTERVENTION BARRIER

Light, modular structure and polyester fabric panels for quick installation by a single operator.

Reference	Description	(mm)
		Dimensions
AL-325	Set of 3 panels	1710 x 1 000
AL-326	Additional panel	570 x 1 000



AL-325



AL-326

BENEFITS

- High visibility with the neon yellow Colour.





SAFETY BOUNDARY POSTS

PVC foldable boundary post. Outdoor and indoor use. 2 hooks for chain assembly. Ballasted base.

Reference	 (cm)	Characteristics	
	Dim.		Weight
AL-316*	Height: 90	Red/white	4
AL-318**	Height: 90	Yellow/black	4
* Use with chain delineators AL 31/05 and 31/25. ** Use with chain delineators AL 32/05 and 32/25.			



AL-316



AL-318

PVC boundary post. Outdoor and indoor use. 2 hooks for chain assembly.

AL-321 and AL-322 : hollow fillable base.

AL-323 and AL-324 : concrete filled base.

Reference	 (cm)	Characteristics	
	Dim.		Weight
AL-321*	Height: 90	Red/white	0.625
AL-322**	Height: 90	Black/yellow	0.625
AL-323*	Height: 90	Red/white	3
AL-324**	Height: 90	Black/yellow	3
* Use with chain delineators AL 31/05 and 31/25. ** Use with chain delineators AL 32/05 and 32/25.			



AL-321



AL-322



AL-323



AL-324

CHAIN DELINEATORS

PVC chains, High resistance to UV.

Reference	Characteristics				
		Dimensions	Chain link		Weight
AL-31/05	Red/white	5 m Length	8	70 x 27	0.5
AL-31/25	Red/white	25 m Length	8	70 x 27	3.75
AL-32/05	Black/yellow	5 m Length	8	70 x 27	0.55
AL-32/25	Black/yellow	25 m Length	8	70 x 27	3.75
AL-31	Set of 10 connecting links red/white	0.45 m Length	6.5	52 x 30	0.065



SAFETY ADHESIVE TAPE

Reference		Fixing
	Dimensions	
AT-5005	100 m Length x 50 mm Width	Adhesive tape black/yellow



AT-5005



SIGNALLING TAPE

High tear resistance tape. Not adhesive.

Reference	
	Dimensions
AL-138	80 mm x 500 m
AL-139	50 mm x 100 m
AL-140	50 mm x 100 m



AL-138

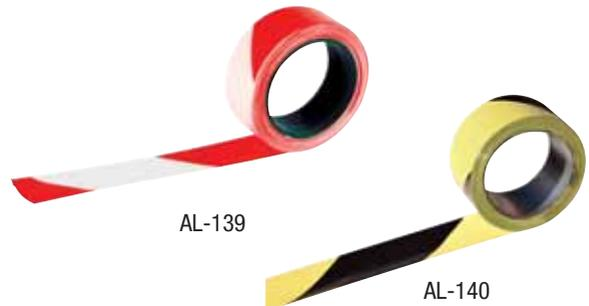

AL-139

AL-140



BENEFITS

- Two-sided printing, made with eco-friendly inks.



TEXTILE TAPE DELINEATORS

Reference	Characteristics		Colour
		Dim.	
AL-127	Fluorescent fabric ribbon with one reflective band	50 m x 50 mm	HV Red/yellow
AL-129	Fluorescent plastic ribbon	50 m x 50 mm	HV Red/yellow



AL-127



AL-129

TEXTILE TAPE DELINEATORS

Vinyl coated fabric. Hanging system. Wrapped tape in a drum.

Reference	Characteristics	
		Dim.
AL-62-A	Red	20 m Length x 50 mm Width
AL-63-A	Yellow	
AL-65-A	Replacement ribbon for AL-62-A	



AL-62/A

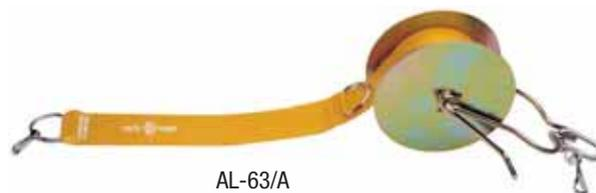

AL-63/A

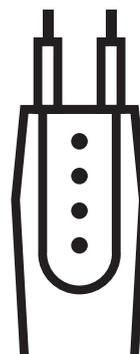

DETECTION / MEASUREMENT

INSTALLATION CONTROLLERS	96
PHASE ROTATION INDICATOR	101
LOW VOLTAGE DETECTORS.....	102
SAFETY TEST PROBES AND ACCESSORIES.....	107
MEDIUM VOLTAGE DETECTORS.....	109
HIGH VOLTAGE DETECTORS	114
MV-HV NON-CONTACT VOLTAGE DETECTORS	116
DISTANCE LIVE-LINE ALARM.....	116
EARTHING CONNECTIONS.....	117



DIGITAL MULTIMETER

The MX-701 is a digital display multimeter (LCD screen 3 + 1/2 backlit digits) high reliability and automatic selection of the measuring range. Indication of low battery level.

Delivered with:

- 2 test probes with right-angled connector IP2X.
- 2 alligator clips.
- 2 thermometric probes.

It measures DC and AC voltages, current continuous and alternating, resistance, inductance, temperature and to test the diodes and the continuity (buzzer).



Reference														
	Voltage	Frequency	Intensity	Resistance	Capacity	Class	Category	T°C	Measure	Screen	Battery	Probes	Dimensions	Weight
MX-701 *	200 mV to 600 V AC / DC	40 - 400 Hz	200 µA to 10 A AC / DC	200 Ω to 20 MΩ	20 nF to 1 000 µF	III	III 600 V	Usage: 0 °C to +40 °C	-20 to 1000°C 0 to +1 800°F	Display 3 + 1/2 digits	3 batteries AAA 1.5 V	x 2	75 x 158 x 35	0.20

*Supplied with batteries and a soft bag.

DIGITAL CLAMP METER

The MX-702 is a compact clamp digital multimeter with display LCD 3 + 1/2 digits with backlight and automatic selection of the measurement range. It measures alternating voltages and continuous, alternating current, resistance, diodes, continuity and temperature. It automatically indicates the polarity and the range overshoot: OL or -OL.

Low battery warning.

Sensor for AC measurements:

- Max. Opening jaws: 36 mm.
- Ø max. conductor width: 30 mm.

Delivered with :

- 2 test probes with angled connector IP2X.
- 1 thermometric probe.



Reference														
	Voltage	Frequency	Intensity	Resistance	Capacity	Class	Category	T°C	Measure	Screen	Battery	Probes	Dimensions	Weight
MX-702 *	2 to 600 V AC 0.2 to 600 V DC	40 - 400 Hz	2 to 600 A AC	200 Ω to 20 MΩ	"buzzer" < 50 Ω	III	III 600 V	Usage: 0 °C to +40 °C	40 to +1000°C -40 to +1832°F	affichage 3 + 1/2 digits	2 batteries AAA 1,5 V	x 2	70x190x38	0.22

*Supplied with batteries and a soft bag.

INFRARED THERMOMETER

NEW

IEC 61000-4-2
IEC 61000-4-3
IEC 61000-4-8
EN 61326

Application:

- High performance infrared thermometer, suitable for detecting abnormal hot spots in electrical installations.
- Automatic measurement of the target temperature (°C and/or °F) without knowing the emissivity of the material or surface properties.
- Not suitable for human temperature measurement.

Features:

- Ratio distance/measure point: 12:1.
- Temperature range: from 32°C à +535 °C (-25°F – 995°F).
- Response time: 500 ms.

Reference					
	T°C	Measure	Battery	Dimensions (mm)	Weight
MX-704 *	from 0 to +50°C	-32 to +535°C -25 à +995°F	1 battery 9 V 6 LR61	130 x 180 x 40	0.19

*Supplied with batteries and a soft bag.



SCAN-ELEC: DETECTS LIVE AC WIRES AND METALLIC PARTS

NEW

SCAN-ELEC
MX-710

CE

Application:

- Detects live AC wires until 51 mm depth.
- Detects:
 - ferrous metallic parts until 75 mm depth.
 - non-ferrous metallic parts (ex: copper) until 38 mm depth.

Features:

- Easy start : a unique push button is used to do both calibration and detection.
- SpotLite function: a red arrow is displayed along the wall to indicate the position of the targeted object.
- LCD ColorTrip display: it lights in **BLUE** when detecting metal and in **RED** when detecting live AC wires.
- Power supply: 1 x 9 V battery, type 6LR61 (non included).

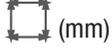
Reference				
	T°C	Battery	Dimensions (mm)	Weight
MX-710	Usage: 7°C to +41°C	1 battery 9 V 6 LR61	160 x 80 x 32	0.2



BENEFITS

- **SAFETY:** ensures the absence of dangerous parts (live wires, fluid lines).
- **TIME SAVING:** Thanks to SpotLite™ pointer and its LCD display screen, SCAN ELEC quickly locates hidden parts.
- **EFFICIENCY:** Easy to use: a push on the side button allows both calibration and detection.



INSTALLATION CONTROLLERS

INSULATION CONTROLLER CATEX™ DT-500

The DT-500 controls the insulation resistance of installations and devices. IEC 60364 standard recommends to check the insulation resistance regularly. Insulation resistance is measured between each active conductor and the ground (when not live). Its value should be 500 kΩ for a DC testing voltage of 500 V.

The DT-500 device is designed to easily, quickly and safely measure the insulation resistance.

It provides a safety system that prevents a measurement when connected to a live installation.

Measures insulation resistance below 500 V DC

The insulation resistance value is indicated by illuminating a light:

- **RED** for values including 0, 300, 400 kΩ.
- **GREEN** for values including 500, 600, 700, 800, 900, 1 000 k and kΩ and ∞.

IP2X test-lead point **YELLOW/GREEN** (ground).

3 large opening alligator clips:

RED, **YELLOW/GREEN**, **BLUE**.



Picture of installation without presence voltage.



M-951981



EN 61010-1 / EN 61557-2



The DT-500 is supplied with a belt clip and storage slots for the test-lead points.



IP2X test-lead point **BLUE** (neutral) independent and connected by a safety terminal.

Accessories

Reference	Characteristics
M-951981	BLUE probe for replacement *
M-87292	Carrying bag *
M-881602	BLUE alligator clip for replacement
M-881601	YELLOW/GREEN alligator clip for replacement

* To be ordered separately.

BENEFITS

- Battery status indicator light.
- The DT-500 can bypass the phase and neutral in order to protect sensitive equipment (electronics, computers, etc.).

Reference		mesures							(mm)	kg
	Output voltage	Resistance	Protection	Class	Category	T°C	Battery	Test-end points	Dimensions	Weight
DT-500 *	< 500 V DC	from 0 to ∞	IP54 IK06	II	Cat III 600V IEC 61010-1	Use: -15 °C to +45 °C	4 LR6 batteries	IP2X	213 x 75 x 46	0.60 with batteries and accessories

* Controller delivered with 3 probes, 3 alligators clips and batteries.

FOCUS

EXPERT

DT-300: EARTH AND CONTINUITY SPECIAL TESTER

Measure of the earth resistance, carried out by this device, is based on the so-called "fault loop" measuring principle.

The CATOHM™ DT-300 allows you to control

by display on LCD screen:

- presence of voltage and conformity of the network,
- the position of the phase,
- the grounding effectiveness,
- the ground resistance value,
- check the continuity of metal grounds by sound signal.



Control on 2P+T socket with touchpad overextender.

- ① Total autonomy (without battery)
- ② Use on 2P+T socket or LV cabinet with cord
- ③ Instant display of the conformity on the two-colour screen (Red and Blue)
- ④ Measures the earth loop without tripping the circuit breakers: < 15 mA



EARTH AND CONTINUITY MEASUREMENT DEVICE CATO^{HM}™ DT-300

CATO^{HM}™ DT-300 is designed based on the IEC 61557-4 standard. The device measures earth resistance using the “default loop” principle.

The CATO^{HM}™ DT-300 shows the following on its LCD display:

- The presence of voltage and compliance,
- The position of the phase,
- The earthing of the production conductor, the main functions being to measure the ground resistance value and to thus check the continuity of metal grounds by sound signal.

Once connected to properly connected installation, the earthing value is instantly measured and displayed at the top of the LCD display, indicating ground resistance values:

- 0 to 100 Ω, **BLUE** numbers (< the 100 threshold Ω)
- 101 to 1999 Ω, **RED** digits

The measurement is taken with an accuracy of +/- 3% + 1 digit for pure resistance, ranging 0-200 Ω, at 23°C +/- 5°C.

Uses 2P+T 10/16 A or LV panel for single-phase 230V circuits between phases and neutral. IP2X connection wells on the test-lead point. 4-digit display of the grounding value in Ω. Continuity extended 7 m along the roller (Ø 105 x H 62 mm). IP2X test-lead point with retractable sheathing. Checks the continuity of metal grounds.



EN 61010-1 / EN 61557-4



M-921647



M-952271

Measurement example without with non-conforming grounding, display in red.



Value < 100 Ω.



Connection between phases under 400 V.



Grounding value > 100 Ω.

Accessories in option:

Reference	Characteristics
M-952271	Lead set for checks on L.V. distribution board. Length 80 cm.

Reference												
	Voltage	50-60 Hz	Continuity	Voltage present	Protection	Class	Category	°C	Screen	Grounding	Dimensions (mm)	Weight
DT-300*	230 V TT network system	•	Measured at ≤ 2 Ω	400 V	IP40 IK06	II	Cat. III 600 V	Use: -15 °C to +45 °C	4-digit screen display	< 2 000 Ω	71 x 210 x 51	0.62 0.36

* Controller delivered with probes and extension on roller.

PHASE ROTATION INDICATOR DETEX MS-152 +

Signalling via the successive lighting of diodes symbolising the rotation.

“**FAULT**” diode lits: phase cut off or incorrectly connected. Phase rotation activated ≥ 85 V.

A set of diodes is turned on and off successively.

The diodes indicate:

- Clockwise rotation indicated by the green arrow “**OK**”,
- Anti-clockwise rotation indicated by the red arrow “**INVERSE**”,
- Default: the **DEFECT** diode (DEFAUT) indicates an error of connection such as the cut off or absence of phase or the presence of neutral between phases.

Probes with retractable protector with 1.20 flexible cable.

GREEN - CX-35811.

YELLOW - CX-45411.

BROWN - CX-34211.

Isolated crocodile clamp IP2X:

YELLOW - CX-01422.

PRO

EN 61557-7 
CE



Rotate right
(clockwise)



Rotate left
(anti clockwise)



Default

BENEFITS

- Compact.
- User friendly visualization viewing the rotation LED.
- Works on generators.

Carrying bag with strap, included. (ref. M-87290)



Reference				IV				
	Voltage	Frequency	Protection	Category	Phase rotation direction	IP2X test-lead points. IEC 61010-31	Dimensions (mm)	Weight
MS-152 +	90-400 V	45/60 Hz	IP54 IK06	600 V EN 61010-1	•	•	200 x 120 x 50 = storage	100

* Delivered in storage bag with 3 probes (GREEN, YELLOW, BROWN) 2 crocodile clamps (YELLOW BROWN). Test probes and crocodile clamps also available separately.

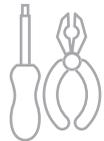



LOW VOLTAGE DETECTORS

Detex™+
MS-918-L



IEC 61243-3:2015

EN 50110-1



Probes.



M-952325



Lighting lamp at the measuring point.



Ergonomic adapter.

BENEFITS

- Lighting unit.
- Phase rotation detection check (two-wire method).
- Voltage light for 12 to 900 V AC (1000 DC).

Accessories in option

Reference	Characteristics
M-87285	Carrying bag with belt loop
M-952325	Board hanger
M-762118	Ergonomic adapter



M-87285

Reference												
	Voltage	Hz	Continuity	Protection	Class	Category IV	T°C	2 AAA batteries	Rotary Field	Suitable for standard 2P+T.	Lighting unit	Weight
MS-918-L*	12-900V AC 12-1000V DC	50/60 +/- 10 %	100 Ω	IP65 IK06	II	600 V	Use: -15 °C to +45 °C (class N)	1,5 V	•	19 mm	•	210

* Supplied without accessories.



FOCUS

EXPERT

AC & DC LOW VOLTAGE DUAL POLE TYPE MS-918-L

The versatile MS-918-L provides operator with voltage detection (compliant with IEC 61243-3:2014) and additional functions such as continuity, phase rotation and phase detection.

Fitted with safety probes, the MS-918-L covers a wide voltage range from 12 to 900 V AC and 12 to 1 000 V DC.



- 1** Robust and ergonomic. With a protection (IP65) and a good impact resistance (IK06) the MS-918-L range is suitable for all environment.
- 2** Wide range of use. Voltage detector from 12 to 900 V AC and 1000 V DC – CAT IV 600 V and CAT III-1000V.
- 3** Self-test function. Enables full verification of the adequate unit functioning (batteries, cords, electronics).
- 4** LED display.



LOW VOLTAGE DETECTORS

DETEX™ 917-L AND 918-L VOLTAGE DETECTORS AND TESTERS

The Detex™ MS-917-L and 918-L are compliant with the IEC 61243-3 standard, in response to the requirements of the EN 50110-1 European standard.

Optical and acoustic signalling, suitable for indoor/ outdoor use. It enables to detect presence of voltage and:

- Checks voltage levels from 12 to 690 V AC, 750 V DC (MS 917-L) and from 12 to 900 V AC, 1 000 V DC (MS-918-L).
- Sound and light continuity for a non-live circuit (threshold of 200 Ω for MS-917-L and 100 Ω for MS-918-L),
- Unipolar phase identification,
- Search for the polarities of a DC circuit,
- Phase rotation by the two-wire method only for MS-918-L.

1 m long double-insulated flexible cords.



The configuration with both test lead points mounted on the detector allows for a 19 mm gap to reflect the standardized EU power sockets.

PRO

IEC 61243-3:2015

EN 50110-1



Detex™+
MS-917-L



MS-917-L

BENEFITS

MS 917-L

- Test-lead points. Point Ø 2 mm and 19 mm lengths for socket contact.
- Hazardous voltage indicator light (> 50 V).
- Phase identification light (unipolar).
- Self test button.
- Completely compatible with the following socket types : C, D, E, F, K, N.



Reference						IV				
	Voltage	Hz	Continuity	Protection	Class	Category IV	T°C	2 AAA batteries	Suitable for standard 2P+T.	Weight
MS-917-L*	12-690 V AC 12 -750 V DC	50/60 +/- 10 %	200 Ω	IP65 IK06	II	600 V	Use: -15 °C to +45 °C (class N)	1.5 V	19 mm	210

* Supplied without accessories.

DETEX™ MS-920-EX VOLTAGE DETECTOR AND TESTER

The Detex™ MS-920-EX is designed based on IEC 61243-3 standard, in response to the requirements of the EN 50110-1 European standard.

Sound and lighting equipment, suitable for indoor/ outdoor use.

It enables to detect absence of voltage and:

- Check of voltage levels > 50 V DC and AC,
- Up to 690 V AC and 950 DC,
- Continuity sound control for a non-live circuit (< 100 Ω),
- Unipolar identification of the phase,
- Search for the polarities of a DC circuit,
- Rotary field by the two-wire method.
- Resolution: 1 V
- Precision: ± 5 %

BENEFITS

- Test-lead points according to IEC 61010-031 Point Ø 2 mm and 19 mm lengths for socket contact.
- Three digit colour LCD screen display.
- Test button.
- Hazardous voltage indicator light when voltage > 50 V.
- Completely compatible with socket types: C, D, E, F, K, N.
- Lighting unit.

CONTACT PROBES FOR L.V. TESTER

Light and rigid contact probes for Detex™: MS-917-L, MS-918-L and MS-920-EX. Contact probes to be used as suspension hooks (MS-8014). Round tip contact (MS-8013).

Reference	↔	⚖
	Length (cm)	Weight
For installations and sidewalk boxes		
MS-8013	50	0.40
For overhead lines		
MS-8014	125	0.75

Delivered in storage bag 50 x 150 x 550 mm.



IEC 61243-3:2015

EN 50110-1



Detex™
MS-920-EX



MS-920-EX



The configuration with both test lead points mounted on the detector housing allows for a 19 mm gap between points, enabling the simultaneous double contact for standardized sockets (2P+T, 10/16 A).



MS-8013

MS-8014



Hatch for storage of test probe.





LOW VOLTAGE DETECTORS



Polarity

Example of 24 V DC detection, display is **BLUE** because < 50 V.



Rotary Field indicator

Unipolar identification of the phase.

Hazardous voltage indicator light (> 50 V).

Example of detecting 230 V AC, displayed in **RED**.



M-952325 Board hanger provided on the back of the device.



M-87285



Lighting lamp at the measuring point.



MS-920-EX storage configuration.

Accessories in option:

Reference	Characteristics
M-87285	Carrying bag with belt loop
M-952325	Board hanger

Reference													
	Voltage	Hz	Continuity < 100 Ω	Protection	Class	Category IV	°C	Display	2 AAA batteries	Rotary Field	Suitable for standard 2P+T.	Lighting unit	Weight
MS-920-EX*	12-690 V AC 12-950 V DC	50-60	200	IP65 IK06	II	600 V	Use: -15 °C to +55 °C (class N)	3 digits	1,5 V	•	19 mm	•	210

HAND STICK

For distance working 2 removable elements. Field of use: 1 000 V max.
Ergonomic handle. Connecting test probe via standard socket.

Reference	Characteristics	↔	kg
		Length (cm)	Weight
M-951143	Hand stick	80	0.24
M-952439	Extension	40	0.12

Delivered in storage bag.



AC AND DC VOLTAGE CONTROLLER

Application:

- Ergonomically optimized voltage tester, ideal for use in tight spaces thanks to its electrode extensions (250 mm and 500 mm).
- It provides a wide detection range for maximum nominal voltages: from 50 to 4 200 V DC and from 50 to 3 000 V AC.

Features:

- Maximum nominal voltage: 3 500 V DC, 2 500 V AC.
- Detection voltage: 50 to 4 200 V DC, 50 to 3 000 V AC.
- Threshold voltage: 50 V +0, -10% (DC and AC).
- Permanent standby status mode (no on / off switch).
- Built in testing system (including the lead check).
- High brightness green LED to indicate the good status of your voltage detector and display the standby state (during 2 min).
- Frequency range: 50-60 Hz ±10%.
- Relative humidity: 20% to 95%.
- Protection degree: IP40 / IK06.
- Double isolation class II.
- Conical test points: diameter 6 mm, length 19 mm.
- Delivered assembled.

Accessories included:

1 set of peak test tip diameter 3 mm, length 19 mm.

Reference	Description	□ (mm)	kg
		Dimension	Weight
MS-415	Voltage controller with storage bag. 2 contact electrodes extension (L: 250 and 500 mm)	550 x 160 x 50	0.78
MS-415-P	Voltage controller with telescopic probes. (Folded: 625 mm, deployed: 982 mm) and storage bag. Cable length : 2 500 mm, 1 set of peak test tip.	950 x 200 x 70	1.22
MS-415-P5	Same as MS-415-P with cable length : 5 000 mm.	950 x 200 x 70	1.5

EMC Directive 2014/30/EU
(EN 61 326-1, EN 62311
EN 61243-3 (partially) ⚡





VOLTAGE TAKE-OFF PUNCH

The voltage take-off punch is able to make an insulated piercing on a low voltage wire to plug a measurement device. Steel pin. Insulated body. Female socket for safety test probe \varnothing 4 mm.

Reference	 (mm)	
	Clamping capacity	Weight
MS-62	\varnothing 5.6 - 14.4	54
MS-63	\varnothing 12 - 31	58



LEAD SET FOR CHECKS ON L.V DISTRIBUTION BOARD

Earthing connection via alligator clip. Safety test probes with retractable sleeve. Female socket Standard 2P+T.

Reference	Characteristics
M-952271	Lead set for checks on L.V distribution board * L 0.80 cm
<small>* For DT-300 and DT-170.</small>	



STORAGE BAG

Reference	 (mm)	Characteristics
	Dimensions	
M-87285	180 x 70 x 45	Storage bag with belt loop for MS-917, MS-918, MS-920
M-87290	200 x 120 x 50	Storage bag with strap for MS-152+
M-87292	250 x 200 x 70	Flexible storage bag with handle



M-87290



M-87285



M-87292

VOLTAGE DETECTOR FOR CAPACITIVE TERMINALS OF ELBOW MV CONNECTOR

In compliance with the standard SPS EDF N° 42. Maximum operating network voltages: 30 kV . Rated voltage max. : 36 kV.
 Note: This detector is directly positioned on networks but behind a capacitive divider. Recommended insulating stick : CC-45-K (length: 1,25 m).

Reference	Characteristics	□ (mm) with case	kg
		Dimensions	Weight
CC-161-K*	Voltage detector for test points of the separable connectors networks from 10 to 30 kV	130 x 180 x 40	0.82
CC-162-K*	Voltage detector for test points of the separable connectors networks from 3 to 36 kV.		
CC-45-K	Insulating stick 45 kV.	1.25 m	0.6

* Device delivered in hard shell case.



VOLTAGE DETECTOR FOR M.V. SUBSTATION (INDOOR USE)

Built-in device for the checking operation. The indication “voltage presence” is visualized on 360° by a high brightness red LED.

High environmental resistance:

Shocks, drop, vibration. Rugged molded thermoplastic housing. External Ø 58.5 mm length (detector equipped with its insulating pole): 1.25 m.

Telescopic stick version for reduced space requirement.



BENEFITS

- Battery lifetime : above 8 years.
- The indication “voltage presence” is visualized on 360°.

Reference	~	↔ Folded up (m)	↔ (m)	kg
	Voltage	Length	Length	Weight
CL-465-10/30-M *	10 - 30 kV	-	1.35	1
CL-465-10-36-M	10 - 36 kV		1.35	1
CL-465-10/30-2 **	10 - 30 kV	0.75	1.18	0.9
CL-465-10-36-C	10-36 kV		0.27	0.4

* Delivered in vinyl sheath with wall mounting brackets CI-06-D.
 ** Delivered in canvas bag, waterproofed with ramp.

CL-465-10-30-M
CL-465-10-36-M

CL-465-10/30-2



MEDIUM VOLTAGE DETECTORS



We can deliver complete set with foot capacitance, head capacitance and wirings to your own specifications. Please consult us.

INTEGRATED VOLTAGE PRESENCE INDICATING SYSTEM (V.P.I.S)

IEC 62271-206

Indicates the voltage presence on M.V. cubicles by being installed on the capacitive dividers. Voltage of use behind capacitive dividers: 1 000 V (between phase and neutral). Light threshold: 90 V. Signaling: 3 neons. Attachment: male/female plugs. Sound phase comparator. MX-404.

Reference	Characteristics	 (mm)	 kg
		Dimensions	Weight
CL-495-3	Delivered complete with connector assembly	130 x 30	0.85

Every order has to be verified and validated by CATU.



INTEGRATED VOLTAGE DETECTING SYSTEM (V.D.S)

IEC 62271-206 

Indicates the voltage presence on M.V. cubicles by being installed on the capacitive dividers. Voltage of use behind capacitive dividers: 1 000 V (between phase and earth). Light threshold: 70/90 V. Input impedance: 36 MΩ. Signalling by 3 red diodes. Sound phase comparator.

Reference	Characteristics	 (mm)	 kg
		Dimensions	Weight
CL-497-00	Delivered complete with connector assembly	146 x 30	0.90

Every order has to be verified and validated by CATU.



SOUND PHASE COMPARATOR*

EN 61243-5 

The MX-404 sound phase comparator checks the concordance between 2 phases. The comparator's operation is indicated by: Emission of an audible signal when there is discrepancy between the two phases. Absence of an audible signal when there is no discrepancy between the two phases. Power supply: 9 V type 6LR battery.

Reference	Characteristics	 (mm)	 kg
		Dimensions	Weight
MX-404 *	Delivered with case	145 x 80	0.90

*This comparator does not work on Schneider electric cells V2 type.



IEC ELECTRONIC VOLTAGE DETECTOR “ULTRA COMPACT SERIES” FOR INDOOR AND OUTDOOR USE

Electronic voltage detector “ultra compact series” for indoor and outdoor use: with ultimate “head capacitive technology”. Compact and light, it works over a wide voltage range, on networks of 50 and 60 Hz. Also available with a dual range of voltage (CC-775) on request.

FOCUS

EXPERT



- ❶ Illuminated information with a 360° visibility.
- ❷ Compact (Ø: 59 mm, length: 280 mm) and light (350 g).
- ❸ Wide voltage range (Example: 10 to 36 kV).

Presence of voltage indicated by:

- red LED flashing (high brightness: visible at more than 20 m in direct lighting),
- powerful rated audible signal > 67 dB (A) /1.5 m).



MEDIUM VOLTAGE DETECTORS

IEC ELECTRONIC VOLTAGE DETECTORS (MV), “COMPACT SERIE” FOR INDOOR AND OUTDOOR USE

Ultimate technology of voltage detector “Head Capacitive Technology»

Compact and light, it offers a wide band (10/36 kV).

Operating check

By pressing the TEST button:

- A RED LED flashes on.
- Powerful rated audible signal > 67 dB(A)/2 m (aligned with IEC 61243-1 and to protect employee from too strong signal).
- When loosening the button, the timed GREEN LED lights up. While remaining on, it indicates the good working order of the detector.

Characteristics

- Precise and stable operating threshold.
- High environmental resistance (impacts, vibrations, moisture).
- Temperature conditions: class N (IEC 61243-1 standard).
- Use from 50 to 60 Hz.

Composition

- Robust housing.
- Weight: 350 g.
- Dimensions: Ø 59 x 270 mm.

Supplied in a rigid packaging to protect the device.



IEC 61243-1 :2003+ AC1: 2005 +A1: 2009



CC-765...C

End fitting C

CC-765...K

End fitting K



BENEFITS

- Results visible over 360° with a powerful light. Voltage range pre-selected to your application.

Reference		Operating voltage		
	Frequency		Type 6 LR-61	Weight
CC-765-2/72-(*)	50/60 Hz	2 - 72 kV	9 V	0.35
CC-765-3/10-(*)	50/60 Hz	3 - 10 kV	9 V	0.35
CC-765-5/18-(*)	50/60 Hz	5 - 18 kV	9 V	0.35
CC-765-5,5/20-(*)	50/60 Hz	5.5 - 20 kV	9 V	0.35
CC-765-10/30-(*)	50/60 Hz	10-30 kV	9 V	0.35
CC-765-10/36-(*)	50/60 Hz	10 - 36 kV	9 V	0.35
CC-765-11/33-(*)	50/60 Hz	11 - 33 kV	9 V	0.35
CC-765-15/45-(*)	50/60 Hz	15-45 kV	9 V	0.35
CC-765-20/66-(*)	50/60 Hz	20 - 66 kV	9 V	0.35
CC-765-30/66-(*)	50/60 Hz	30 - 66 kV	9 V	0.35
CC-765-44/132-(*) ⁽¹⁾	50/60 Hz	44 - 132 kV	9 V	0.35
CC-765-63/90-(*) ⁽¹⁾	50/60 Hz	63 - 90 kV	9 V	0.35

(*) Specify type of mounting when ordering: C or K.

(1) supplied with 1 hook-shaped contact electrode CC-ANT 120 (Ø120 mm).
Packaging: unit supplied complete in a case with batteries and contact electrodes (straight and V-shaped).
For other voltages, please consult us.

CC-775 : 2 voltage ranges detector, in compliance with IEC 61343-1

Reference	1st voltage range		2nd voltage range	
	Un min (uu)	Un Max (vv)	Un min (xx)	Un Max (yy)
CC-775-2/7-12/25-(*)	2 kV	7 kV	12 kV	25 kV
CC-775-2/72-12/36-(*)	2 kV	7.2kV	12 kV	36 kV
CC-775-2/72-34/115-(*)	2 kV	7.2 kV	34 kV	115 kV
CC-775-33/11-22/66-K	3.3 kV	11 kV	22 kV	66 kV
CC-775-4/14-24/69-K	4 kV	14 kV	24 kV	69 kV
CC-775-4/144-25/69-K	4 kV	14.4 kV	25 kV	69 kV
CC-775-47/15-25/69-K	4.7 kV	15 kV	25 kV	69 kV
CC-775-6/12-22/66-C	6 kV	12 kV	22 kV	66 kV
CC-775-11/22-33/66-K	11 kV	22 kV	33 kV	66 kV
CC-775-12/24-52/132-(*)	12 kV	24 kV	52 kV	132 kV

(*) End fitting : C or K



C

K

End fittings:

C: hexagonal 12 mm, for hexagonal end-fitting sticks,
K: universal, for universal end-fitting sticks.

Recommended stick:
CE-4-21, CE-75, CE-9.



BIPOLAR VOLTAGE DETECTOR FOR DIRECT VOLTAGE

Application :

- Bipolar DC voltage detector: 100 V to 30 kV DC.
- The low threshold set to 100 V makes it possible to detect any voltage exceeding the limits of the low voltage DC.
- Indoor use (Use only on laboratory and workshop type installations).

Characteristics :

- Voltage presence indicated by:
 - Lighting of 6 red diodes.
 - Acoustic signal (60 dB (A) / 2 m).
- 380 mm contact electrode.
- Overall length of the detector: 840 mm.
- Indication group: III.

Composition:

- 2 elements with removable probes, connected by a cable.
- 1 transport case.



Reference		Contact electrode		
	DC Voltage		Length (cm)	Weight
CL 6-120-5000 *	120-5 000 V	ANTP	910	1.5
CL 6-100-30000**	100-30 000 V	ANTP	910	1.5

*Delivered in a heavy duty plastic case.
** Delivered in a heavy duty plastic case with 2 types of electrodes (tulip and tapered).

- Total length: 1.075 m.
- Probe length: 350 mm.
- Cable length: 1.9 m.
- Weight complete device: 2 kg.



Mechanical and dielectric tests
Compliant with NF EN 61243-2 





HIGH VOLTAGE DETECTORS

IEC VOLTAGE DETECTORS (HV) FOR OUTDOOR USE

Precise and stable operating threshold. Insensitivity to induced voltages by limiting the operating voltage range. Remarkably resistant to impacts, vibrations, extreme temperatures, humidity.

Double signalling.

Voltage presence indicated at the same time by:

- 4 bright **RED** flashing electro-luminescent diodes (visible at more than 50 meters even in direct lighting),
- a powerful rated acoustic signal (60 dB/2 m).

The CC-265 detector is supplied with 3 end fittings for stick mounting:

W: Hexagonal 20 mm,

C: Hexagonal 12 mm,

K: Universal.

Robust housing made from polycarbonate with high mechanical properties and dielectric strength.

Check that the device is working by pressing the TEST button. This test all of the detector's active components once the TEST button is released.

Two **GREEN** illuminated lights, indicating that the device is on. These lights turn off, and four **RED** lights illuminate when a voltage is detected.

Power supply : 1 battery 9 V type 6LR61 (included).

Storage temperature : - 25 /+ 55°C.



IEC 61243-1 :2003+ AC1: 2005 +A1: 2009



BENEFITS

- Illuminated display Broadcast over 360°.
- Use in rain conditions.
- Shock Absorber fitting.
- New fixation ring (for the hook).

NEW

- 360° vision for optimal visibility.
- Delivered with 3 end fittings.

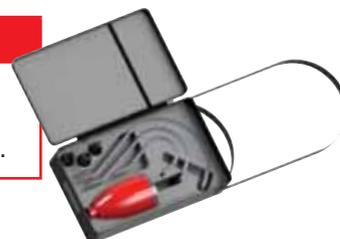

Reference	~	Housing Colour	IEC 61243-1	Contact electrode	Contact electrode (Ø mm)	kg
	Voltage range					Detector weight
CC-265-44/132 (*)	44 - 132 kV	■	•	CC-ANT120	120	0.68
CC-265-60/90 (*)	60 - 90 kV	■	•	CC-ANT60 & CC-ANT120	60 - 120	0.68
CC-265-60/150 (*)	60 - 150 kV	■	•	CC-ANT60 & CC-ANT120	60 - 120	0.68
CC-260-60/235 (*)	60 - 235 kV	■	-	CC-ANT120	120	0.68
CC-265-90/225 (*)	90 - 225 kV	■	•	CC-ANT120	120	0.68
CC-265-120/245 (*)	120 - 245 kV	■	•	CC-ANT200	200	0.68
CC -260-132/380 (*)	132 - 380 kV	■	-	CC-ANT200	200	0.68
CC-260-150/420 (*)	150 - 420 kV	■	-	CC-ANT200	200	0.68
CC-265-225/420 (*)	225 - 420 kV	■	•	CC-ANT60, CC-ANT120, CC-ANT200	60, 120, 200	0.68
CC-260-225/550 (*)	225 - 550 kV	■	-	CC-ANT200	200	0.68

Delivered with modern, lightweight and impact-resistant case.

(*) Please specify type of mounting when ordering: C or K

For other voltage ranges, please consult us.



IEC ELECTRONIC VOLTAGE DETECTOR WITH PROBE, FOR INDOOR AND OUTDOOR USES

Ultimate "head capacitive technology" of voltage detector.

- Universal application 50 / 60 Hz and wide band of voltage from 5 to 30 kV.
 - Type S (Substation) with electrode extension.
- The electrode extension is designed to ensure no inside failure.
- Equipped with its insulating stick : Assembly by screwing.

Voltage presence is indicated by:

- RED flashing LED (very bright, visible at more than 20 m in direct lighting).
- Powerful rated audible signal > 67 dB (A) / 1.5 m.

Characteristics:

- Temperature conditions: class N (-25 to 55°C).
- Type S (with electrode extension).
- Electrode extension diameter : 14 mm.
- Power supply: 1 standard 9 V battery 6LR61.
- Network frequencies : 50 and 60 Hz.
- Contact electrodes fitted by screwing and easily interchangeable.
- Packaging: supplied in a carrying bag with zip (930 mm x 200 mm) and transparent side pocket (CM-1-10).
- CE marking complies with EMC immunity regulations.

Reference	Characteristics			
		Frequency	(m)	Weight
CC-965-10/30	With stick and probe	10 - 30 kV	Length: 1.55 m Diameter: 59 mm	850
CC-965-5/15	With stick and probe	5 - 15 kV	Length: 1.45 m Diameter: 59 mm	820
CC-965-5/15-C	With probe	5 - 15 kV	Probe length: 590 mm	530
CC-965-10/30-C	With probe	10 - 30 kV	Probe length: 690 mm	530
CC-965-10/30-K	With probe	10 - 30 kV	Probe length: 690 mm	530

Accessories

Reference	Characteristics
M-78723	Plastic carrying case
CM-1-10	Canvas bag



BENEFITS

- 360 ° light indication.
- Delivered in a waterproof canvas bag.
- With insulating stick.

IEC 61243-1 :2003+ AC1: 2005 +A1: 2009





MV-HV NON-CONTACT VOLTAGE DETECTORS

NON CONTACT VOLTAGE DETECTOR

NEW

Application:

Non-contact voltage detector, voltage range from 3 to 765 kV.
Ultra-compact, switchless series for indoor and outdoor use.

Features:

Nominal network range: 3-765 kV.
Precise and stable operating threshold.
Reduced sensitivity to induced voltages and to interference field.
Temperature conditions : class N (-25 to 55°C).
Power supply: 1 standard 9 V battery 6LR61.
Network frequencies: 50 and 60 Hz.
Switchless device to ensure permanent operator safety.

Reference	~	
	Voltage range	Weight
CN-7-003-012-K	3 kV to 12 kV	300
CN-7-005-036-K	5 kV to 36 kV	300
CN-7-010-036-K	10 kV to 36 kV	300
CN-7-011-066-K	11 kV to 66 kV	300
CN-7-066-410-K	66 kV to 410 kV	300
CN-7-220-500-K	220 kV to 500 kV	300
CN-7-315-765-K	315 kV to 765 kV	300



CN-7 series

IEC 61326-1



BENEFITS

- High environmental resistance (impacts, vibrations, moisture) due to robust thermoplastic housing.
- Approximate detection distances (varying with the environment) : 150 mm min (11 kV) to 700 mm min (66 kV).
- 360° light indication.
- Self test function.

DISTANCE LIVE-LINE ALARM

Application:

- ALED3 is an additional device ensuring safety to the operator within live powered environments warning him about a risk of danger.
- Improved safety of the operator: presence of an electric field (1kV to 66 kV) as identified by a sound and visual warning.
- Flexibility: 360° detection sensor depending on the position of the device which can be installed in different ways (on a helmet, on the arm, on the belt, on the body).
- Easy to use : compact and light with an in-built antenna.

Characteristics:

- The alarm is automatically triggered when the operator approaches an electric field and turns off when he moves away from the source.
- 360° detection according to the positioning of the device which has multiple fixing possibilities (helmet, arms, belt, body).
- Compact and light with integrated antenna.
- Sound intensity : 75 dB
- Response time : < 1 s.

Reference	~	~		
	Voltage	Frequency	Dimensions (mm)	Weight
ALED3	1 - 66 kV	1 - 60 Hz	66 x 56 x 39	85

NEW

EN 61326-1:2013

EN 63211-1:2008





EARTH RESISTANCE TESTER

The **MX-430-M** allows the measurement of earth resistance and earth specific resistivity and also the parasite voltages caused by grounding parasitic voltage presence.

This equipment is suitable for fast and easy measurement of the grounding resistance in home, industrial buildings, substations,...

Technical features

- Application: measurement of grounding resistances (with 3 earth rods), earth resistivity (with 4 earth rods) and parasite voltage presence.
- Range of measurement: 0 - 20 Ω ; 0-200 Ω ; 0-2000 Ω and 20 KΩ.
- Voltmeter: voltmeter function in AC range as a conventional voltmeter 0-200 V AC.
- Operation frequency: 1470 Hz.
- Current in and out put power: less than 0,5 W and the output current is limited to less than 15 mA (peak to peak).
- Operation temperature: -10°C / +50°C.
- Storage temperature: -25°C / +65°C.
- Humidity: 95% RH (non-condensing).

Composition:

- 230 V charger.
- 12 V car charger plug and cable.
- Protection case, robust and waterproof.
- Carrying bag.



Reference	 (mm)	 kg
	Dimensions	Weight
MX-430-M	221 x 189 x 99	2

BENEFITS

- High visibility 3 1/2 digit display with direct readings, even under sunlight.
- Connexion wire including a 12 V car plug.
- Rechargeable internal battery managed by a microprocessor which modulates the load current as per the status of the battery, thus increasing battery life and the service life of the device.





ACCESSORIES (MEASUREMENT KIT) MX-433-T

- 1 storage bag.
- 4 earth rod copper plated steel.
- 1 x 5 m black cable.
- 1 x 40 m red cable.
- 2 x 20 m cable (1 blue and 1 green).
- 1 x 5 m green cable to connect to the grounding system.
- 1 hammer.
- 1 x 50 m reel measure tape.

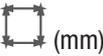

Reference	 (mm)	 kg
	Dimensions	Weight
MX-433-T	570 x 220 x 160	7.7



LV EARTHING SYSTEMS

OVERHEAD BARE	120
OVERHEAD INSULATING	122
EARTHING EQUIPMENT FOR ELECTRIC MOTORS	123
LV CABINETS	126



OVERHEAD BARE

SHORT-CIRCUITING SYSTEMS

Set of 4, 5, 6 or 7 clamps MT-411.
 An extra-flexible 16 mm² copper cable assembly.
 An insulated socket with a bayonet, for connecting a grounded system.
 Telescopic stick 2 m CE-2-21/1-C.
 Waterproof bag MT-400-01.

Reference	Description	
		Weight
MT-404	3 MT-411 + 1 MT-411-C	3.4
MT-405	4 MT-411 + 1 MT-411-C	3.8
MT-406	5 MT-411 + 1 MT-411-C	4.2
MT-407	6 MT-411 + 1 MT-411-C	4.6



EARTHING EQUIPMENT FOR OVERHEAD LINES SYSTEMS

Grounding device connecting with the earth rod MT-650.
 Insulated pin connecting to a short circuit socket.

Reference		Earth Clamp	
	Cable (m x mm ²)		Weight
MT-242	2 x 16	MT-840/1	1
MT-244	10 x 10	MT-840	2.5
MT-245	10 x 16	MT-840/1	3
MT-249	15 x 16	MT-840/1	3.8

Packaging: polypropylene case 310 x 280 x 105 mm.





SHORT-CIRCUITING AND EARTHING SYSTEMS NEVERS ENEDIS TYPE

Short-circuit ENEDIS networks for pruning trees. Implementation from the ground up to 10.5 m (sticks + operator) without climbing. Insulating stick made of resin polyester/ glass fiber tube diameter 36.

Reference	Description	
		Weight
MT-509/3	3 Telescopic metallic sticks, 3 elements, L = 2.37/6.15 m + 1 Telescopic metallic stick, 3 elements (the last one insulating yellow), L = 2.37/6.15 m + 1 insulating stick, 2 elements, L = 1.65/3.3 m + 1 multi-strand of 4 cables, L = 6 x 16 mm ² with 2 female sockets + 1 stick raise-up + 1 stick support	19 (3 bags)
MT-509/3EP	1 Telescopic metallic stick, 3 elements L = 2.37/6.15 m + 1 cable, L = 6 x 16 mm ² with male socket	2.3
MT-509/3VAT	1 Telescopic metallic stick, 3 elements (the last one insulating yellow), L = 2.37/6.15 m	2.5

Equipment packed in carrying bags.

Reference	Description	
		Weight
CC-127-ENEDIS-C	Specific voltage detector Range : 127-400 V	0.45

Accessories

Reference	Description
M-952567	Multi strand of 5 copper cables
M-952270	Insulating sticks support
MT-546	Insulating sticks raise up
M-611386	Raise up sticks
M-952568	Earth cable



Earth cable
M952568



Voltage detector
CC-127-ENEDIS-C



Multi strand of 5 copper
cables M952567w



Insulating sticks
raise up MT-546



Insulating sticks support
M952570



Insulating sticks Nevers type.raise up MT-546

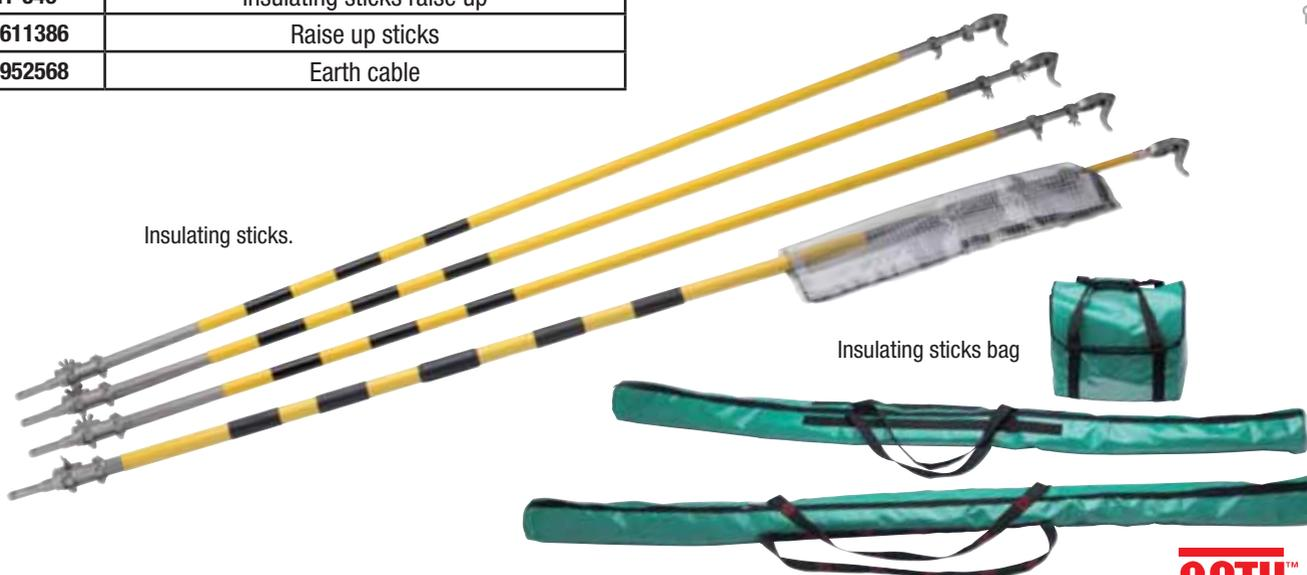

Insulating sticks.

Insulating sticks bag

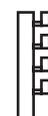

LOWLOCK SYSTEM

IEC 61230 :2008

For Ø 3 to 21 mm conductors. With clamps type "snap-on/screw-on".
Connecting cables: 35 mm² copper. Short-circuiting and earthing systems.

Reference	Rating	Composition	
			Weight
MT-615/1-7.5	7.5	5 MT-616/1-03 contact clamps on handles (l = 0.35 m each) 4 braids of M-24-35 copper cable (1.00 m) 1 M-87-153 carrying bag 250 x 85 x 750 mm	3
MT-615/2-7.5	7.5	5 MT-616/1-03 contact clamps on handles 4 braids of M-24-35 copper cable (1.00 m) 1 braid of M-24-35 copper cable (7.00 m) 1 MT-840/1 earth clamp	6.5



SHORT-CIRCUITING SYSTEMS

IEC 61230 :2008

Equipment includes either 5 or 6 copper-aluminium alloy stubs. Connector for conductor MT-222 or MT-223, see below, to be ordered separately. Set of 4, 5, 6 or 7 clamps. Extra-flexible 16 mm² copper cable assembly.

Reference	Socket	
		Weight
MT-205	5	1.1
MT-206	6	1.5
MT-207	7	1.9

Packaging : polypropylene case 234 x 215 x 75 mm.

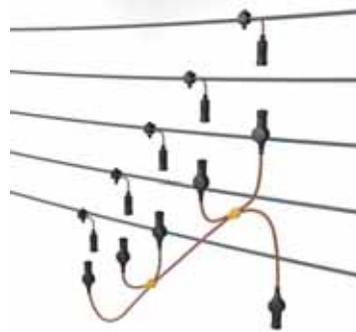

Icc: 4 kA/1s

Connectors for conductors

Reference	
	Cable (m x mm ²)
MT-222	16 x 25
MT-223	35 x 70

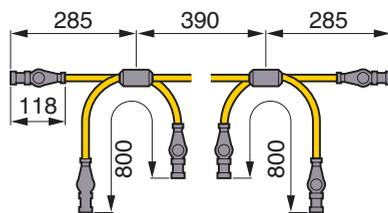

EARTHING EQUIPMENT

IEC 61230 :2008

Earth rod. Earthing equipment with bayonet splicing for overhead lines systems. Galvanized steel. Hexagonal 18 mm per side.

Reference		
	Length (m)	Weight
MT-650	1	2.2

To be ordered in addition to short circuit and grounding equipment.





EARTHING AND SHORT-CIRCUITING EQUIPMENT FOR ENGINES AND LOW VOLTAGE INSTALLATIONS IN THE INDUSTRY AND THE TERTIARY SECTOR

Application:

Earthing and short-circuiting equipment for industrial motors.
Unique and innovative: Finally, a solution adapted to the problems of all industrial engines.

Security: Ensures the earthing of installations during maintenance.

Easy and safe to use.

Universal: Suitable for most installations.

Allows working on cables of all sections with or without lugs.

Features:

Maximum short circuit intensity 14 000 kA / 1s.

1 body made of copper alloy.

Connection points for earthing and short-circuiting cables equipped with lug terminals and fixing hole greater than 8 mm.

Connection points for earthing and short-circuiting cables with bare ends and maximum diameter 8 mm.

1 earthing cable made of copper with extra flexible PVC insulation, cross-section 50 mm², length 2 m.

1 earthing clamp MT-8401.

1 protection cover.cable PVC insulated, cross-section 50 mm², length 2 m.

Waterproof protection cover with « Earth » marking.

Reference	Description	
		Weight
MC-281	Equipment Icc 14 kA/1s	1.5

BENEFITS

- Innovative.
- New on the market.
- Simple and quick to assemble.
- Supplied with a waterproof protection cover.



Icc 14 kA/1s
EXCLUSIVE EARTHING SOLUTION
FOR INDUSTRIAL MOTORS.

IEC 61230 :2008 

NEW



Waterproof protection cover

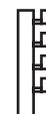

EARTHING AND SHORT-CIRCUITING EQUIPMENT, QUICK TO ASSEMBLE, FOR ENGINES AND LOW VOLTAGE INSTALLATIONS IN THE INDUSTRY AND THE TERTIARY SECTOR

Application:

Earthing and short-circuiting equipment for industrial motors. Unique and innovative: Finally, a solution adapted to the problems of all industrial engines.

Security: Ensures the earthing of installations during maintenance. Easy and safe to use.

Universal: Suitable for most installations.

Allows working on cables of all sections with or without lugs.

Features:

Maximum short circuit intensity 10 000 kA / 1s.

1 body made of copper alloy.

Connection points for earthing and short-circuiting cables equipped with lug terminals and fixing hole greater than 8 mm.

Connection points for earthing and short-circuiting cables with bare ends and maximum diameter 8 mm.

1 earthing cable made of copper with extra flexible PVC insulation, cross-section 50 mm², length 2 m.

1 earthing clamp MT-8401.

1 protection cover.

Icc 10 kA/1s
EXCLUSIVE EARTHING SOLUTION
FOR INDUSTRIAL MOTORS.
QUICK STEP.

IEC 61230 :2008

NEW



Waterproof protection cover

Reference	Description	kg
		Weight
MC-281/1	Equipment Icc 10 kA/1s	1.4

BENEFITS

- Innovative.
- New on the market.
- Quick assembly by one clamping point.
- Supplied with a waterproof protection cover.



EARTHING AND SHORT-CIRCUITING EQUIPMENT, QUICK TO ASSEMBLE, FOR ENGINES AND LOW VOLTAGE INSTALLATIONS IN THE INDUSTRY AND THE TERTIARY SECTOR

Application:

Equipped with a locking earthing clamp. This clamp is suitable to prevent switching on the power on the circuit breaker before having dismantled the earthing system.

Equipment particularly adapted for earthing and short-circuiting of motors or installations in which the power cables have thin cross-sections with the ends equipped, or not, with lugs.

The system is provided with a waterproof protective bag which will cover the body of the earthing system after assembling.

Reference	Icc (kV)	Connections For cables with lugs	Connections	Cable
				(m x mm ²)
MC-281/870	14	x 3 Fixing hole ≥ 8 mm	x 3 diam. bare extremity ≤ 8 mm	2 x 50
MC-2811/870	10	x 3 Fixing hole ≥ 4 mm	For thin cross-sections	2 x 35

Features:

Earthing connection by locking clamp MT870 and extra flexible copper cable PVC insulated, cross-section 50 mm² and 35 mm², length 2 m.

Waterproof protection cover with « Earth » marking.

Reference	Description	kg
		Weight
MC-281/870	Equipment Icc 14 kA/1s	1.6
MC-2811/870	Equipment Icc 10 kA/1s	1.6

BENEFITS

- The locking earthing clamp secures the consignment process.
- Innovative.
- New on the market.
- Simple and quick to assemble.
- Supplied with a waterproof protection cover.

WITH SECURED CLAMP.
EXCLUSIVE EARTHING SOLUTION
FOR INDUSTRIAL MOTORS
AVOIDING FORGETTING EARTHING
EQUIPMENT.

IEC 61230 :2008 

NEW



MC-281/870



MC-2811/870

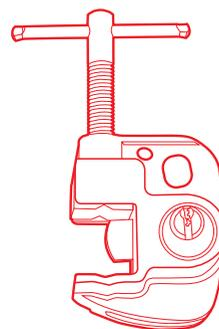

SECURED EARTHING CLAMP

- Earthing clamp paired with a lockout padlock, using the same «prisoner» key.
- Exclusive CATU system imposing an installation and dismantling order for operator safety.



SHORT CIRCUITING DEVICE FOR LV CABINET

The earthing works is a mandatory operation in the NFC 18510 (chp 7.1 - Processes log) standard.

Tinned copper insulated cable silicone core 16 mm².

Authorized employment ENEDIS equipment.

Composition A: for connection.

Composition B: for network.

Composition C: for connection and network. Maximum Icc: 4kA/1s

IEC 61230 :2008



Reference	Description
MC-296-A	4 multi-strand copper cables 16mm ² MC-296-440 + 1 micro clamps MC-296-P* + 1 connecting blade M-95627/4* + 1 round cartridge M-95626/4* + 1 cartridge size 00 MC-296-00/08* + 1 open end spanners 13/14/16/17 MO-687-D + 1 handle MC-296-M + 1 Case with foam and notice M-91209
MC-296-B	4 multi-strand copper cables 16mm ² MC-296-440 + 5 multi-strand copper cables 16mm ² M-952656 + 1 micro clamps MC-296-P* + 1 cartridge size 115 MC-296-115/08* + 1 cartridge size 160 MC-296-160/08* + 1 threaded adapters MC-181* + 1 pipe wrench 10x17mm M-882462 + 1 open end spanners 13/14/16/17 MO-687-D + 1 handle MC-296-M + 1 case with foam and notice M-91209
MC-296-C	4 multi-strand copper cables 16mm ² MC-296-560 + 5 multi-strand copper cables 16mm ² M-952656 + 5 micro clamps + 1 connecting blade M-95627/4* + 1 round cartridge M-95626/4* + 1 cartridge size 00 MC-296-00/08* + 1 cartridge size 115 MC-296-115/08* + 1 cartridge size 160 MC-296-160/08* + 1 threaded adapters MC-181* + 1 pipe wrench 10x17mm M-882462 + 1 open end spanners 13/14/16/17 MO-687-D + 1 handle MC-296-M + 1 case with foam and notice M-91209

* Sold in packs of 4.
Other composition on request.



MC-296-00/08



MC-296-115/08



MC-296-160/08



MC-296-M



M-95626/4



M-95627/4



MC-296-P



Interventions on LV Cabinets.

SHORT CIRCUITING DEVICES FOR LV INDUSTRIAL CABINETS

The earthing works is a mandatory operation in the NFC 18510 (- Processes log chp 7.1) standard.

Composition:

- 5 multi-strand copper cables.
- 5 micro clamps + 1 Case and notice M-76768.

Reference	Section (mm ²)	Icc (kA/1s)
MC-296-NFC-16	16	4
MC-296-NFC-25	25	7
MC-296-NFC-35	35	10



IEC 61230 :2008



THREADED ADAPTERS

Smooth threaded terminals for positioning shunts ((LV Live working tools) or LV earthing equipment and LV short circuit cabinets terminals.

Reference	Description	Composition (by reference, delivered in a vinyl bag)	
			Weight
MC-184-6F	Smooth threaded terminal M6 female	Set of 4 adapters	120
MC-182	Smooth threaded terminal M8 female	Set of 4 adapters	150
MC-185-10F	Smooth threaded terminal M10 female	Set of 4 adapters	200
MC-183	Smooth threaded terminal M12 female	Set of 4 adapters	250

Reference	Description	Composition (by reference, delivered in a vinyl bag)	
			Weight
MC-184-6M	Smooth threaded terminal M6 male	Set of 4 adapters	120
MC-182-8M	Smooth threaded terminal M8 male	Set of 4 adapters	150
MC-185-10M	Smooth threaded terminal M10 male	Set of 4 adapters	200
MC-181	Smooth threaded terminal M12 male	Set of 4 adapters	250



MC-182

MC-183



MC-181

IEC 61230 :2008



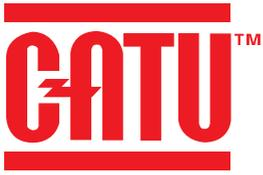

TESTING
ACCREDITATION N°1 - 0897
SCOPE AVAILABLE ON
www.cofrac.fr



SERVICES

Testing laboratory
Flexible workshop
Training
Maintenance
Technical support

After sales service

xavier.lebec@catuelec.com

Phone : +33 1 42 31 46 85

latif.ozmen@catuelec.com

Phone : +33 1 42 31 46 86

Technical support

corinne.peigne@catuelec.com

Phone : +33 1 42 31 46 24

charles.saulnier@catuelec.com

Phone : +33 1 42 31 63 10



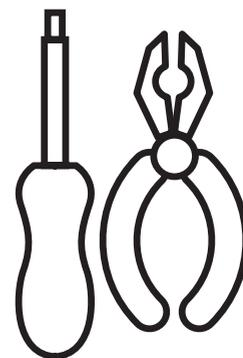

LV LIVE WORKING TOOLS

INSULATED TOOLS	130
INSULATED TOOLS KITS	155
INSULATED SCREWDRIVERS AND JUMPER ACCESSORIES	158



INSULATED TOOLS

FIND THE TOOLS TO MEET YOUR NEEDS!

IEC 60900 : 2018

Insulated tools must comply with the IEC 60900 : 2018 standards. To meet these standards, insulated tools undergo electrical and mechanical tests.

Compliance with the IEC 60900: 2018 standard guarantees the user to work in safety with voltages up to 1000 V AC and 1500 V DC

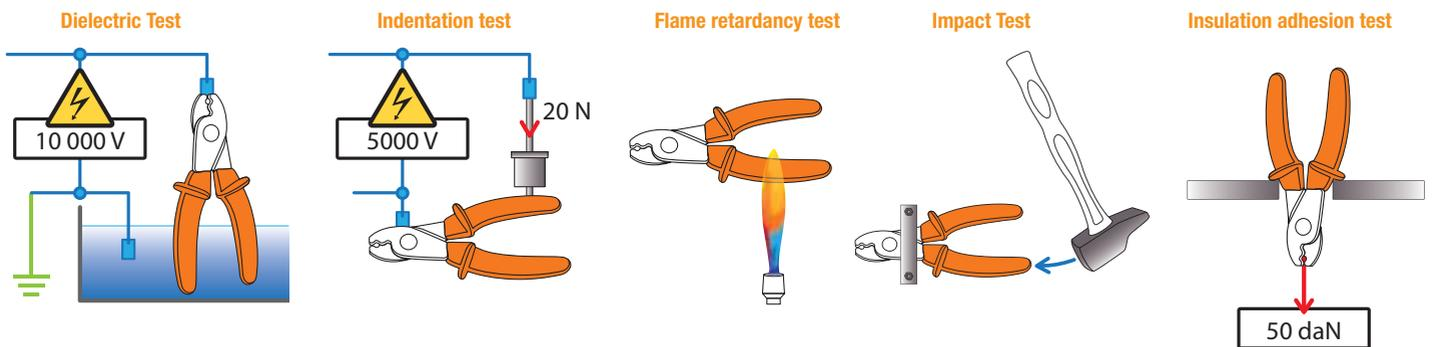

Dual Material Insulated Tools



PRO

- Premium grip with the SOFTGRIP® dual material handle.
- Chrome steel body, mat finish.

Adapted to the :

- Building electricians, heating and air conditioning maintenance technicians.
- Mobile maintenance.

Dual Layer Insulated Tools



**EXP
ERT**

- Double layers insulating handles
- The first layer guarantees the insulating performance. (White color).
- The second layer provide mechanical protection. (Orange color).
- High performing burnished steel.
- Increased security with the oversized guard.

Made for :

- Operations on electricity production and transmission infrastructures.
- The industrial maintenance.
- The electric and hybrid automotive maintenance.

DUAL MATERIAL, FLAT BLADE SCREWDRIVERS

Reference	∅	↔	g
	Diam. (mm)	Blade length (mm)	Weight
MO-72002	2.5	60	30
MO-72003	3	100	40
MO-72004	4	125	50
MO-72005	5	150	70
MO-72006	6	150	90
MO-72008	8	175	150
MO-72010	10	200	220



IEC 60900 : 2018 ⚠



DUAL MATERIAL, POZIDRIZ SCREWDRIVERS

Reference	PZ N°	↔	g
		Blade length (mm)	Weight
MO-72040	PZ 0	60	25
MO-72042	PZ 1	100	60
MO-72044	PZ 2	125	90
MO-72046	PZ 3	150	150
MO-72048	PZ 4	200	220

IEC 60900 : 2018 ⚠

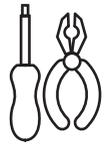

DUAL MATERIAL, PHILLIPS SCREWDRIVERS

Reference	PH N°	↔	g
		Blade length (mm)	Weight
MO-72030	PH 0	60	25
MO-72032	PH 1	100	60
MO-72034	PH 2	125	90
MO-72036	PH 3	150	150
MO-72038	PH 4	200	220

IEC 60900 : 2018 ⚠



BENEFITS

- Magnetic blade in chrome vanadium steel.
- Hanging hole at the top of the handle.
- Bi-material non-slip insulating handle.



INSULATED TOOLS

DUAL MATERIAL, TORX SREWDRIVERS

Reference	N°	↔	
		Blade length (mm)	Weight
MO-72056	T 6	50	25
MO-72057	T 7	50	25
MO-72058	T 8	50	25
MO-72059	T 9	75	35
MO-720510	T 10	75	35
MO-720515	T 15	75	50
MO-720520	T 20	100	70
MO-720525	T 25	100	80
MO-720527	T 27	115	90
MO-720530	T 30	125	100
MO-720540	T 40	125	120
MO-720545	T 45	150	160
MO-720550	T 50	175	200



IEC 60900 : 2018 



DUAL MATERIAL, MALE HEXAGONAL SCREWDRIVERS

Reference	On flats (mm)	↔	
		Blade length (mm)	Weight
MO-68402	2.5	75	40
MO-68403	3	75	50
MO-68404	4	100	70
MO-68405	5	100	80
MO-68406	6	125	100
MO-68408	8	150	150

IEC 60900 : 2018 



DUAL MATERIAL, CABLE CUTTER PLIERS

Reference	↔		
	(mm)	Cu / Al (mm)	Weight
	Total length	Cutting capacity	
MO-72200	160	∅ 5 max	230

IEC 60900 : 2018 



DUAL MATERIAL, WIRE STRIPPING PLIERS

Reference	↔	 Cu / Al	
	Total length (mm)	Stripping capacity	Weight
MO-72172	160	0.5 to 10 mm ²	170

DUAL MATERIAL, UNIVERSAL PLIERS

Reference	↔	 Cu / Al (mm)			
	Total length (mm)	Cutting capacity			Weight
					
MO-72102	180	Ø 3.5	Ø 2.2	Ø 1.5	280

● Steel: 75 daN / mm² ● Steel: 180 daN / mm² ● Steel: 220 daN / mm²

DUAL MATERIAL, FLAT NOSE PLIERS

Reference	↔	
	Total length (mm)	Weight
MO-72132	160	170

DUAL MATERIAL, BENT SNIPE NOSE PLIERS

Reference	↔	 Steel (mm)			
	Total length (mm)	Cutting capacity			Weight
					
MO-72142	160	Ø 2.5	Ø 1.6	Ø 1	170

● Steel: 75 daN / mm² ● Steel: 180 daN / mm² ● Steel: 220 daN / mm²

BENEFITS

- Bi-material non-slip and ergonomic handle.
- High resistant chrome vanadium steel.

PRO

IEC 60900 : 2018 



IEC 60900 : 2018 



IEC 60900 : 2018 



IEC 60900 : 2018 





INSULATED TOOLS

DUAL MATERIAL, ROUND NOSE PLIERS

Reference		
	Total length (mm)	Weight
MO-72122	160	160



IEC 60900 : 2018



DUAL MATERIAL, MULTIGRIP PLIERS

Locking twin slip-joint.

Reference			
	Total length (mm)	Maximal opening (mm)	Weight
MO-72155	250	32	350



IEC 60900 : 2018



DUAL MATERIAL, DIAGONAL CUTTERS

Chrome-vanadium steel. Dual material handle. Anti slip material.

Reference					
	Total length (mm)	Cutting capacity			
MO-72162	160	Ø 3 Ø 2.2 Ø 1.5	210		

● Steel: 75 daN / mm² ● Steel: 180 daN / mm² ● Steel: 220 daN / mm²

IEC 60900 : 2018



BENEFITS

- Bi-material non-slip and ergonomic handle.
- High resistant chrome vanadium steel.



DUAL MATERIAL, SCREWDRIVERS KITS

Reference	Composition
KIT-23	Flat blade screwdriver 4 x 125 mm MO-72004 Flat blade screwdriver 6 x 150 mm MO-72006 Flat blade screwdriver 8 x 175 mm MO-72008 POZIDRIV screwdriver N°1 MO-72042 POZIDRIV screwdriver N°2 MO-72044



IEC 60900 : 2018



DUAL MATERIAL, PLIERS KITS

Reference	Composition
KIT-27	Universal pliers 180 mm MO-72102 Water pump pliers 250 mm MO-72155 Wire stripping pliers 160 mm MO-72172 Bent snipe nose pliers 160 mm MO-72142 Cable cutter 160 mm MO-72200



DUAL MATERIAL, INTERVENTION KITS

Reference	Composition
KIT-24	Flat blade screwdriver 4 x 125 mm MO-72004 Flat blade screwdriver 6 x 150 mm MO-72006 Flat blade screwdriver 8 x 175 mm MO-72008 POZIDRIV screwdriver N°1 MO-72042 POZIDRIV screwdriver N°2 MO-72044 Wire stripping pliers 160 mm MO-72172 Bent snipe nose pliers 160 mm MO-72142 Cable cutter 160 mm MO-72200



DUAL MATERIAL, COMPLETE INTERVENTION KITS

Reference	Composition
KIT-25	Flat blade screwdriver 4 x 125 mm MO-72004 Flat blade screwdriver 6 x 150 mm MO-72006 Flat blade screwdriver 8 x 175 mm MO-72008 POZIDRIV screwdriver N°1 MO-72042 POZIDRIV screwdriver N°2 MO-72044 Universal pliers 180 mm MO-72102 Multigrip pliers 250 mm MO-72155 Wire stripping pliers 160 mm MO-72172 Bent snipe nose pliers 160 mm MO-72142 Cable cutter 160 mm MO-72200



OTHER KITS ON REQUEST





INSULATED TOOLS

FLAT BLADE SCREWDRIVERS

Reference	∅	↔	g
	Diam. (mm)	Blade length (mm)	Weight
MO-65202	6.5	40	38
MO-65203	3	100	33
MO-65204	3.5	100	37
MO-65205	4	100	46
MO-65206	5.5	125	75
MO-65207	6.5	150	94
MO-65209	8	175	165
MO-65211	10	200	195
MO-650-D	Set of 3 screwdrivers MO-65205 / MO-65207 / MO-65209		
MO-652-D	Set of 4 screwdrivers MO-65203 / MO-65205 / MO-65207 / MO-65209		



IEC 60900 : 2018



POZIDRIV SCREWDRIVERS

Reference	∅	↔	g
	Diam. (mm)	Blade length (mm)	Weight
MO-65240	PZ 0	60	25
MO-65242	PZ 1	80	50
MO-65244	PZ 2	100	75
MO-65246	PZ 3	150	150
MO-65248	PZ 4	200	230

IEC 60900 : 2018



PHILLIPS SCREWDRIVERS

Reference	∅	↔	g
	Diam. (mm)	Blade length (mm)	Weight
MO-65230	PH 0	60	25
MO-65232	PH 1	80	50
MO-65234	PH 2	100	75
MO-65236	PH 3	150	150
MO-65238	PH 4	200	230
MO-653-D	Set of 3 screwdrivers N°0. N°2 et N°3		

IEC 60900 : 2018



BENEFITS

- Non-slip and ergonomic handle.
- High end chrome vanadium steel.

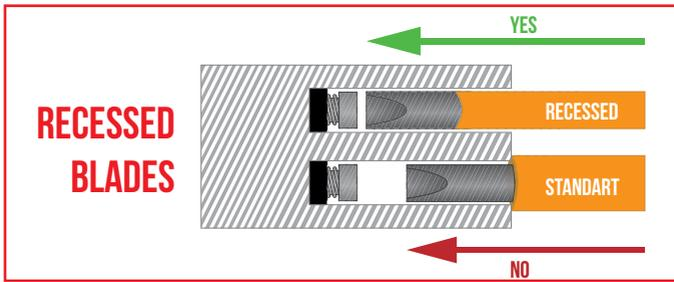

FLAT BLADE SCREWDRIVERS WITH RECESSED BLADES

Reference	∅	↔	g
	Diam. (mm)	Blade length (mm)	Weight
MO-65200D	6.5	40	36
MO-65202D	2	70	16
MO-65203D	3	100	30
MO-65204D	4	120	52
MO-65205D	5.5	100	50
MO-652055D	5.5	150	72
MO-65206D	6.5	150	36
MO-65208D	8	150	92
MO-652082D	8	200	142
MO-65210D	10	150	166
MO-652102D	10	250	282
MO-65212D	12	250	318



IEC 60900 : 2018

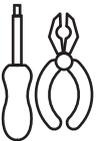

POZIDRIV SCREWDRIVERS WITH RECESSED BLADES

Reference	∅	↔	g
	Diam. (mm)	Blade length (mm)	Weight
MO-652405D	5	40	34
MO-652406D	6	40	34
MO-65244D	PZ 0 (4)	75	50
MO-652441D	PZ 0 (4)	150	55
MO-65245D	PZ 1 (5)	100	60
MO-65246D	PZ 2 (6)	125	82
MO-65248D	PZ 3 (8)	150	146
MO-652410D	PZ 4 (10)	200	256

IEC 60900 : 2018



PHILLIPS SCREWDRIVERS WITH RECESSED BLADE

Reference	∅	↔	g
	Diam. (mm)	Blade length (mm)	Weight
MO-65232D	PH 0 (4)	75	50
MO-652321D	PH 0 (4)	150	55
MO-65233D	PH 1 (5)	100	60
MO-65234D	PH 2 (6)	125	82
MO-65236D	PH 3 (8)	150	146
MO-65238D	PH 4 (10)	200	256

IEC 60900 : 2018





INSULATED TOOLS

FLAT / PHILLIPS BLOCK TERMINAL SCREWDRIVERS

Reference	∅	↔	g
	Diam. (mm)	Blade length (mm)	Weight
MO-65405	5	80	50
MO-65406	6	100	60



IEC 60900 : 2018



FLAT / POZIDRIV BLOCK TERMINAL SCREWDRIVERS

Reference	∅	↔	g
	Diam. (mm)	Blade length (mm)	Weight
MO-65505	5	80	50
MO-65506	6	100	60

IEC 60900 : 2018



UNIVERSAL PLIERS

Reference	↔	g
	Blade length (mm)	Weight
MO-66001	160	210
MO-66002	180	260
MO-66003	200	300
MO-66005	250	510

IEC 60900 : 2018



MO-66002



MO-66005

FLAT NOSE PLIERS

Reference	↔	g
	Blade length (mm)	Weight
MO-66300	145	110
MO-66301	160	160
MO-66302	170	180

IEC 60900 : 2018



BENT NOSE PLIERS

Reference	↔	g
	Blade length (mm)	Weight
MO-66402	160	160
MO-66404	200	180



IEC 60900 : 2018 ⚠



ROUND NOSE PLIERS

Reference	↔	g
	Blade length (mm)	Weight
MO-66202	160	150

IEC 60900 : 2018 ⚠

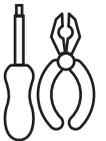

LONG NOSE PLIERS WITH SIDE CUTTER

Reference	↔	g
	Blade length (mm)	Weight
MO-66102	160	140

IEC 60900 : 2018 ⚠



PLUG PLIERS FOR PIN TERMINALS

Reference	↔	g
	Blade length (mm)	Weight
MO-66105	210	200

IEC 60900 : 2018 ⚠





INSULATED TOOLS

MULTIGRIP PLIERS

Reference		(mm)	
	Total length (mm)	Maximal opening	Weight
MO-66505*	250	33	400
MO-66500	410	45	1000

* Double rack slip joint (MO-66505 only).



IEC 60900 : 2018



END CUTTERS

Reference		Acier (mm)		
	Total length (mm)	Cutting capacity		Weight
MO-67401	140	∅ 2	∅ 1	160
MO-67402	160	∅ 3	∅ 2	210
MO-67404	200	∅ 4	∅ 3	450

IEC 60900 : 2018



DIAGONAL CUTTERS

Reference		Acier (mm)			
	Total length (mm)	Cutting capacity			Weight
MO-67101	140	∅ 2	∅ 1	∅ 0.5	150
MO-67102	160	∅ 3	∅ 2.2	∅ 1.5	180
MO-67103	190	∅ 3.2	∅ 2.5	∅ 2	210

IEC 60900 : 2018





CABLE CUTTERS

Reference	↔	 Cu / Al (mm)	 g
	Total length (mm)	Cutting capacity	Weight
MO-67500	180	∅ 5	420
MO-67501	170	∅ 15	280
MO-67502	230	∅ 20	520
MO-67700	590	∅ 16	2500
MO-67701	765	∅ 12	3800



MO-67502



MO-67700



IEC 60900 : 2018 



MO-67500



MO-67501



MO-67701

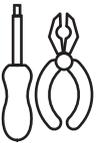

WIRE STRIPPING PLIERS

Reference	↔	 g
	Total length (mm)	Weight
MO-67302	160	170

IEC 60900 : 2018 



FULLY INSULATED WIRE STRIPPING PLIERS

Reference	↔	 g
	Total length (mm)	Weight
MO-67302C	175	260

IEC 60900 : 2018 





INSULATED TOOLS

STRIPPING TOOL FOR LV CABLES

Aluminium casting pliers.

IEC 60900 : 2018

Reference		(mm)		
	(mm)	Stripping capacity	Section mm ²	Weight
MO-67101	220	Ø 8 to 21	16 to 150	470



STRIPPING TOOLS FOR LV CABLES

Aluminium casting pliers.

IEC 60900 : 2018

Reference		(mm)		
	(mm)	Stripping capacity	Section mm ²	Weight
MO-67305	265	Ø 21 to 35	16 to 150	650
MO-67306	270	Ø 26 to 52	50 to 250	670



INSULATING UNIVERSAL PLIERS

Composite insulation. Entirely insulating.

IEC 60900 : 2018

Reference		
	Total length (mm)	Weight
MO-66000C	200	170



INSULATING FLAT NOSE PLIERS

Composite insulation. Entirely insulating.

IEC 60900 : 2018

Reference		
	Total length (mm)	Weight
MO-66303C	190	110





INSULATING BENT HALF ROUND NOSE PLIERS

Composite insulation.

Reference		
	Total length (mm)	Weight
MO-66404CC	210	110

IEC 60900 : 2018



INSULATED KNIVES

Curved blades.

Reference			
	Total length (mm)	Blade length (mm)	Weight
MO-61001	180	62	110
MO-61002	180	68	110

Delivered with pouch.

IEC 60900 : 2018



MO-61001

MO-61002

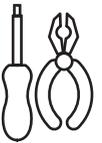

BENEFITS

- Fully insulated in composite materials.

RATCHET CABLE CUTTERS

Treated forged steel blades.

Reference			Aluminium Section mm ²	
	(mm)	Copper section mm ²		Weight
MO-67599	Ø 32 max	260	320	900
MO-67600	Ø 38 max	300	350	950
MO-67601	Ø 55 max	400	450	970

IEC 60900 : 2018



FRONTAL RATCHET CABLE CUTTER

Treated forged steel blades.

Reference			Aluminium Section mm ²	
	(mm)	Copper section mm ²		Weight
MO-67611	Ø 32 max	180	250	900

IEC 60900 : 2018





INSULATED TOOLS

HACKSAWS

2 blade positions : 180° and 90°. Blade tension adjustment.

Reference			
	Total length (mm)	Blade length (mm)	Weight
MO-64501	263	130	150
MO-64502*	450	300	780

* delivered with 2 blades.



IEC 60900 : 2018



ADJUSTABLE WRENCHES

Reference			
	Total length (mm)	Maximal opening	Weight
MO-69002	210	24 max	290
MO-69003	250	28 max	450
MO-69004	310	34 max	550
MO-69005	385	43 max	1350

IEC 60900 : 2018



REVERSIBLE RATCHET RING WRENCHES

Reference		
	On flats	Weight
MO-69210	10	160
MO-69213	13	190
MO-69216	16	350
MO-69217	17	370
MO-69218	18	380
MO-69219	19	390

IEC 60900 : 2018



CROSS WRENCHES

Insulated inserts using one-piece injection.

Reference	 (mm)	 (mm)	
	Dimensions	On flats	Weight
MO-68701	150 x 150	6-8-10-12	220
MO-68702	150 x 150	8-10-12-14	260
MO-68703	150 x 150	7-9-11-13	250
MO-68704	150 x 150	8-10-13-17	250
MO-68705	150 x 150	14-17-18-21	400



IEC 60900 : 2018 



MALE HEXAGONAL KEYS

Reference	 (mm)	 (mm)	
	Dimensions	On flats	Weight
MO-69903	83 x 123	3	30
MO-69904	84 x 124	4	40
MO-69905	85 x 125	5	50
MO-69906	85 x 125	6	70
MO-69908	86 x 126	8	110
MO-69910	88 x 128	10	150
MO-69912	90 x 130	12	240

IEC 60900 : 2018 

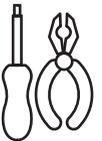

OPEN END WRENCHES

Reference	 (mm)		Reference	 (mm)	
	On flats	Weight		On flats	Weight
MO-68006	6	20	MO-68019	19	170
MO-68007	7	20	MO-68020	20	185
MO-68008	8	40	MO-68021	21	200
MO-68009	9	40	MO-68022	22	220
MO-68010	10	45	MO-68023	23	250
MO-68011	11	50	MO-68024	24	260
MO-68012	12	60	MO-68025	25	280
MO-68013	13	80	MO-68026	26	300
MO-68014	14	100	MO-68027	27	340
MO-68015	15	110	MO-68028	28	360
MO-68016	16	120	MO-68029	29	400
MO-68017	17	140	MO-68030	30	500
MO-68018	18	160	MO-68032	32	570
MO-68008/19	8 open end spanners set: 8/10/11/12/13/14/17/19 mm				680

IEC 60900 : 2018 





INSULATED TOOLS

OFFSET-RING WRENCHES

12 points profiles Reference	 (mm)		Reference	 (mm)	
	On flats	Weight		On flats	Weight
MO-68106	6	30	MO-68119	19	200
MO-68107	7	35	MO-68120	20	240
MO-68108	8	40	MO-68121	21	260
MO-68109	9	45	MO-68122	22	260
MO-68110	10	50	MO-68123	23	270
MO-68111	11	65	MO-68124	24	280
MO-68112	12	80	MO-68125	25	300
MO-68113	13	100	MO-68126	26	360
MO-68114	14	120	MO-68127	27	400
MO-68115	15	150	MO-68128	28	440
MO-68116	16	180	MO-68129	29	480
MO-68117	17	190	MO-68130	30	500
MO-68118	18	195	MO-68132	32	540



IEC 60900 : 2018 



ANGLED SOCKET WRENCHES

Reference	Empreinte	 (mm)		Reference	Empreinte	 (mm)	
		On flats	Weight			On flats	Weight
MO-68205	6 sided	5	20	MO-682181	12 sided	18	330
MO-68206	6 sided	6	30	MO-682191	12 sided	19	430
MO-68207	6 sided	7	35	MO-682211	12 sided	21	500
MO-68208	6 sided	8	45	MO-682221	12 sided	22	633
MO-68209	6 sided	9	60	MO-682231	12 sided	23	680
MO-682101	12 sided	10	85	MO-68224	12 sided	24	730
MO-682111	12 sided	11	100	MO-68226	12 sided	26	810
MO-682121	12 sided	12	130	MO-68227	12 sided	27	1000
MO-682131	12 sided	13	160	MO-68228	12 sided	28	1080
MO-682141	12 sided	14	185	MO-68229	12 sided	29	1130
MO-682151	12 sided	15	220	MO-68230	12 sided	30	1310
MO-682161	12 sided	16	230	MO-68232	12 sided	32	1550
MO-682171	12 sided	17	285				

IEC 60900 : 2018 





HEXAGONAL T HANDLE WRENCHES

Reference		(mm)	
	Lg. (mm)	On flats	Weight
MO-68610	135	10	140
MO-68613	135	13	200
MO-68614	135	14	250
MO-68620	135	20	350
MO-68621	135	21	370



IEC 60900 : 2018



LONG HEXAGONAL T HANDLE WRENCHES

Reference		(mm)	
	Lg. (mm)	On flats	Weight
MO-68310	305	10	350
MO-68311	305	11	360
MO-68312	305	12	370
MO-68313	305	13	400
MO-68314	305	14	450
MO-68316	305	16	560
MO-68317	305	17	650
MO-68319	305	19	750
MO-68321	305	21	800
MO-68322	305	22	850
MO-68713	405	13	650
MO-68714	405	14	800
MO-68717	405	17	900
MO-68719	405	19	1 000
MO-68721	405	21	1 200



IEC 60900 : 2018

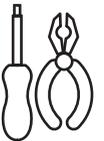

3/8" 6-POINTS FEMALE LONG SOCKETS

65 mm length.

Reference	(mm)		Reference	(mm)	
	On flats	Weight		On flats	Weight
MO-69608	8	55	MO-69616	16	130
MO-69609	9	65	MO-69617	17	140
MO-69610	10	75	MO-69618	18	160
MO-69611	11	85	MO-69619	19	180
MO-69612	12	95	MO-69621	21	200
MO-69613	13	100	MO-69622	22	220
MO-69614	14	115	MO-69623*	23	230
MO-69615	15	120	MO-69624	24	240

* the dimensions 23 and 24 have 12 sides.



IEC 60900 : 2018





INSULATED TOOLS

3/8" 6-POINTS FEMALE SOCKETS

Reference	 (mm)	 g
	On flats	Weight
MO-69306	6	25
MO-69307	7	30
MO-69308	8	30
MO-69309	9	30
MO-69310	10	35
MO-69311	11	35
MO-69312	12	35
MO-69313	13	45
MO-69314	14	45
MO-69315	15	50
MO-69316	16	55
MO-69317	17	60
MO-69318	18	65
MO-69319	19	70
MO-69321	21	85
MO-69322	22	90

* 12 sides.



IEC 60900 : 2018 

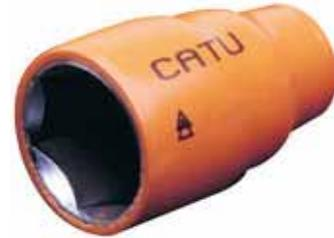

3/8" MALE HEXAGONAL BIT SOCKETS

Reference	 (mm)	 g
	On flats	Weight
MO-69393	3	160
MO-69394	4	180
MO-69395	5	200
MO-69396	6	220
MO-69397	7	240
MO-69398	8	280
MO-693100	10	350

IEC 60900 : 2018 



3/8" MALE TORX BIT SOCKETS

Reference			 g
	Lg. (mm)	Diam. (mm)	Weight
MO-69T15	80	TX15 ★	50
MO-69T20	80	TX20 ★	55
MO-69T25	80	TX25 ★	55
MO-69T30	80	TR30 ★	60
MO-69T40	80	TR40 ★	80
MO-69T45	80	TR45 ★	90
MO-69T50	105	TR50 ★	100

IEC 60900 : 2018 



3/8" EXTENSION

Reference			 g
	Lg. (mm)	Diam. ext. max (mm)	Weight
MO-69523	140	21.5	120
MO-69533	264	21.5	270

IEC 60900 : 2018 



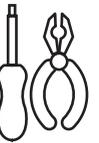

1/4" 6-POINTS FEMALE SOCKETS

Reference	 (mm)	 g
	Female	Weight
MO-69804	4	12
MO-69805	5	12
MO-698055	5,5	12
MO-69806	6	14
MO-69807	7	14
MO-69808	8	16
MO-69809	9	22
MO-69810	10	22
MO-69811	11	26
MO-69812	12	28
MO-69813	13	28
MO-69814	14	32



IEC 60900 : 2018 



1/4" MALE HEXAGONAL BIT SOCKETS

Reference	 (mm)	 g
	Male	Weight
MO-698M03	3	16
MO-698M04	4	18
MO-698M05	5	20
MO-698M06	6	22
MO-698M07	7	24
MO-698M08	8	25

IEC 60900 : 2018 



1/4" EXTENSION

Reference		 g
	Total length (mm)	Weight
MO-69522	170	75

IEC 60900 : 2018 



1/4" DRIVE SCREWDRIVER

Reference			 g
	Total length (mm)	Blade length (mm)	Weight
MO-69540	270	150	150

IEC 60900 : 2018 





INSULATED TOOLS

1/2" 12-POINTS FEMALE SOCKETS

Reference	 (mm)		Reference	 (mm)	
	On flats	Weight		On flats	Weight
MO-69408	8	60	MO-69420	20	90
MO-69409	9	60	MO-69421	21	100
MO-69410	10	60	MO-69422	22	100
MO-69411	11	65	MO-69423	23	115
MO-69412	12	70	MO-69424	24	125
MO-69413	13	70	MO-69425	25	130
MO-69414	14	70	MO-69426	26	135
MO-69415	15	75	MO-69427	27	140
MO-69416	16	75	MO-69428	28	145
MO-69417	17	80	MO-69429	29	150
MO-69418	18	80	MO-69430	30	155
MO-69419	19	85	MO-69432	32	170



IEC 60900 : 2018 



1/4" MALE HEXAGONAL BIT SOCKETS

Reference	 (mm)	
	On flats	Weight
MO-694M04	4	100
MO-694M05	5	100
MO-694M06	6	100
MO-694M08	8	100
MO-694M10	10	100
MO-694M12	12	160
MO-694M14	14	160
MO-694M17	17	180
MO-694M19	19	220

IEC 60900 : 2018 



1/2" EXTENSIONS

Reference			
	Total length (mm)	Diam. ext. max (mm)	Weight
MO-69524	125	26	170
MO-69534	250	26	350

IEC 60900 : 2018 



FOCUS

EXPERT

MO-69522-V INSULATING ADAPTOR FROM 1/4" MALE HEXAGON TO 3/8" SQUARE DRIVE

Use your electric screwdriver with 3/8" square drive insulated sockets and bits.

Fully insulated : Non electric continuity between the 1/4" Male hexagon and the 3/8" square drive.

Could be use with all the electric electric screwdrivers and cordless drill drivers.
Do not use the impact mode.

IEC 60900 : 2018 compliant.
For use with a maximum voltage of 1 000 V AC and 1 500 V DC



- ① Time saving with an unique solution on the market.
- ② Increase productivity and safety.
- ③ Maximum operating torque : 40 Nm : For most operation with a 3/8" square drive.



INSULATED TOOLS

INSULATING ADAPTOR

Insulating adapter 1/4" hexagonal – 3/8" square drive for use with electric screwdriver.

1/4" (6.35 mm) male, hexagonal fitting on one side for fixing on screw driver. Useful length 20 mm.

3/8" (9.52 mm) male, square drive on the other side for fixing 3/8" sockets.

Larger diameter on insulation: 20.5 mm.

Reference		
	Total length (mm)	Weight
MO-69522-V	79	66



IEC 60900 : 2018

1/2" TO 3/8" COUPLER

Reference		
	Total length (mm)	Weight
MO-69539	79	60

IEC 60900 : 2018



3/8" TO 1/4" COUPLER

Reference		
	Total length (mm)	Weight
MO-69535	64	20

1/4" TO 3/8" COUPLER

Reference		
	Total length (mm)	Weight
MO-69537	54	30

IEC 60900 : 2018

3/8" TO 1/2" COUPLER

Reference		
	Total length (mm)	Weight
MO-69536	75	40





MO-69408/23



IEC 60900 : 2018

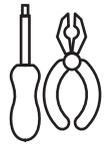

SOCKETS SET 3/8" (9.53 mm)

6 sided.

Reference	(mm)	
	Dimensions	Weight
MO-69308/23	Tools composition on plastic case 410 x 120 x 75	1250

Composition

Reference	(mm)	
	On flats	Weight
MO-69308	8	30
MO-69310	10	35
MO-69312	12	35
MO-69313	13	45
MO-69314	14	45
MO-69317	17	60
MO-69319	19	70
MO-69321	21	85
MO-69322	22	90
MO-69323	23*	100
MO-69513	Reversible ratchet	600
MO-69523	Extension 140	124

SOCKETS SET 1/2" (12.7 mm)

12 sided.

Reference	(mm)	
	On flats	Weight
MO-69408/23	Tools composition on plastic case 410 x 120 x 75	1500

Composition

Reference	(mm)	
	On flats	Weight
MO-69410	10	60
MO-69412	12	70
MO-69413	13	70
MO-69414	14	70
MO-69417	17	80
MO-69419	19	85
MO-69421	21	100
MO-69422	22	100
MO-69423	23	115
MO-69514	Reversible ratchet	600
MO-69524	Extension 130	250

Other references 1/2", consult us.

EMPTY CASE

Reference	Description
MO-69503	Polypropylène case



INSULATED TOOLS

RACHETS

With mechanical locking.

Reference			
	On flats	Total length (mm)	Weight
MO-69512	1/4"	125	150
MO-69513*	3/8"	200	450
MO-69514*	1/2"	250	750

* With mechanical locking.

3/8" SQUARE DRIVE TORQUE WRENCHES

Torque in Nm and Lb / ft.

Torque adjustment by screwing or unscrewing the handle extremity.

MO-69050 non-reversible with right hand thread.

MO-69051 with reversible pawl and right or left hand thread.

MO-69054 with reversible spindle function.

Reference		C Nm	
	Total length (mm)	Torque range	Weight
MO-69050	340	8 to 60	900
MO-69051	230	4 to 20	900
MO-69054	340	8 to 60	900
MO-69060*	340	8 to 60	1000
MO-69025	370	5 to 25	1500
MO-690541	370	5 to 50	1100

FULLY INSULATED SCISSORS

Completely insulated pair of scissors, ambidextrous.

Reference		
	Total length (mm)	Weight
MO-72100E	132	80

DEAD BLOW Mallet

Isolated mallet without rebound. Head diameter: 35 mm.

Reference		
	Total length (mm)	Weight
MO-745-D	310 x 117 x 42	790



IEC 60900 : 2018 



MO-69514 - MO-69513



MO-69512

IEC 60900 : 2018 



MO-69050 no reversible



MO-69051 reversible



MO-69054 reversible

IEC 60900 : 2018 



PRO

IEC 60900 : 2018 





SCREWDRIVERS KIT

Reference	Composition
KIT-03	POZIDRIV screwdriver N°1 MO-65242 POZIDRIV screwdriver N°2 MO-65244 Flat blade screwdriver 3.5 x 100 mm MO-65204 Flat blade screwdriver 5.5 x 125 mm MO-65206 Flat blade screwdriver 8 x 175 mm MO-65209

PLIERS KIT

Reference	Composition
KIT-07	Universal pliers overall length 180 mm MO-66002 Multigrip pliers overall length 250 mm MO-66502 End stripping pliers 160 mm MO-67302 Bent snipe nose pliers overall 160 mm MO-66402 Cable cutter 170 mm MO-67500

INTERVENTION KIT

Reference	Composition
KIT-04	POZIDRIV screwdriver N°1 MO-65242 POZIDRIV screwdriver N°2 MO-65244 Flat blade screwdriver 3.5 x 100 mm MO-65204 Flat blade screwdriver 5.5 x 125 mm MO-65206 Flat blade screwdriver 8 x 175 mm MO-65209 End stripping pliers overall 160 mm MO-67302 Bent snipe nose pliers overall 160 mm MO-66402 Cable cutter 170 mm MO-67500

COMPLETE INTERVENTION KIT

Reference	Composition
KIT-05	POZIDRIV screwdriver N°1 MO-65242 POZIDRIV screwdriver N°2 MO-65244 Flat blade screwdriver 3.5 x 100 mm MO-65204 Flat blade screwdriver 5.5 x 125 mm MO-65206 Flat blade screwdriver 8 x 175 mm MO-65209 Universal pliers overall 180 mm MO-66002 Water pump pliers overall 250 mm MO-66502 End stripping pliers overall 160 mm MO-67302 Bent snipe nose pliers overall 160 mm MO-66402 Cable cutter 170 mm MO-67500



IEC 60900 : 2018

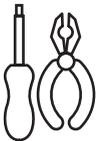



INSULATED TOOLS - KITS

INTERVENTION KIT FOR ELECTRICIANS

Reference	Composition
MO-38510	1 tool bag M-87370 1 pair of insulating gloves size C CG-05-C 1 safety glasses MO-11001 1 safety padlock AL-230-111 1 Flat blade screwdriver 3,5 x 100 mm MO-65204 1 Flat blade screwdriver 5,5 x 125 mm MO-65206 1 Flat blade screwdriver 8 x 175 mm MO-65209 1 POZIDRIV screwdriver n° 1 MO-65242 1 POZIDRIV screwdriver N° 2 MO-65244 1 Universal pliers 180 mm MO-66002 1 Bent snipe nose pliers 160 mm MO-66402 1 Wire stripping pliers 160 mm MO-67302 1 Cable cutter 180 mm MO-67500 1 Multigrip pliers MO-66502



MORE INSULATED TOOLS KITS ON DEMAND

CAT'ARC

ARC FLASH & MULTI-RISK PROTECTIVE CLOTHING

ANTI-PANIC ZIP!

KNEES AND CROTCH REINFORCEMENT

RAPID IDENTIFICATION!

IEC 61482-2
Arc Flash Protection

EN ISO 11612
Heat and flame protection

EN ISO 11611
Welding and allied processes protection

EN 1149-5
Electrostatic discharge protection

Simple and effective everyday protection

SICAME GROUP



RECOMMENDED EQUIPMENT FOR LIVE WORKING OPERATIONS IN LOW VOLTAGE COMPLIANT WITH THE PRESCRIPTION OF EN 50110 STANDARD



Face shield with MO-510-03

Electrician helmet with MO-510-03/2

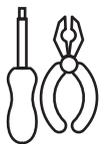

Reference	Composition
MO-510-03 *	With face shield MO-286
MO-510-03/2 *	With electrician helmet MO-185-BL

* Delivered without tool bag.

Composition
PERSONAL EQUIPMENT
1 face shield with kit MO-510-03 1 electrician- helmet with kit MO-510-03/2 1 work gloves size C CG-98-C 1 rubber gloves size C CG-05-C, size 10 1 carrying bag for rubber gloves CG-36-1 1 insulating 2,2 mm MP-11/16
VOLTAGE DETECTOR
1 voltage detector MS-917
ISOLATING
10 insulating caps MP-26-A 1 insulating blanket MP-35/2 10 clamps for insulating blanket MP-4110 6 line protectors 1.50 m MP-32/15 10 insulating adhesive tapes MP-19LOT

Composition (following)
INSULATING TOOLS
1 insulated knife-61001 1 cable cutter 230 mm MO-67502 Open end spanners set with: 8 / 10 / 11 / 12 / 13 / 14 / 17 / 19 mm MO-68008/19 1 right angle hexagonal key wrench 3 mm MO-69903 1 right angle hexagonal key wrench 4 mm MO-69904 1 right angle hexagonal key wrench 6 mm MO-69906 1 insulating folding rule MO-751 1 adjustable spanner 250 mm MO-69003 1 universal pliers 180 mm MO-66002 1 round nose pliers 160 mm MO-66202 1 Water pump plier 250 mm MO-66502 1 side cutter 160 mm MO-67102 Sockets 3/8" wrench set with a 1 reversible ratchet and 1, Extension MO-69308/23 1 flat blade screwdriver 4 x 100 MO-65205 flat blade screwdriver 6,5 x 150 MO-65207 1 flat blade screwdriver 8 x 175 MO-65209 1 Phillips screwdriver n° 1 MO-65232 1 Phillips screwdriver n° 2 MO-65234 1 Phillips screwdriver n° 3 MO-65236





PHASE INDICATOR INSULATED SCREWDRIVER 1000 V

This tool is not a voltage detector. This insulated screwdriver enables to identify the phase from the neutral from 127 V by intermittent lighting of an ultra-bright signal (on the top of the handle).
Maximum voltage use : 1000 V. Insulated handle.
Works with a battery guaranteed for 3 years. Blade with flat blade.



IEC 60900 : 2018

Reference	~	∅	↔	
	Phase	Diam. (mm)	Blade length (mm)	Weight
MO-65222	Voltage detection from 127 V to 1 000 V	4	85	65



THREADED ADAPTERS

Threaded adapters. Cylindrical body diameter 10 mm to fits on panel network thread of switchboard etc... Total length 50 mm.

Smooth bollard		Type	↔	Composition	
Tapped*	Filtered		Longueur (mm)		Weight
MC-184-6F	MC-184-6M	M6	50	Set of 4	120
MC-182	MC-182-8M	M8	50		150
MC-185-10F	MC-185-10M	M10	50		200
MC-183	MC-181	M12	50		250

* Packed by 10 pieces



SHUNT TELESCOPIC PROBES

Connector with insulated probe. Retractable cover.

Reference	Section mm ²	Intensité A	
			Weight
MC-126	1.5 to 16	60	130
MC-126/1	10 to 70	100	146





JUMPER CABLES

LV live working tools. Delivered with socket screwing ISO M8.
Insulated copper cable H 07 RN-F. Nominal intensity 200 A.
Insulated cover.

Reference	↔	Cable Section mm ²	Intensité A	kg
	Length (m)			Weight
MC-153/05	0.5	35	200	0.27
MC-153/10	1	35	200	0.57
MC-153/30	3	35	200	1.72
MC-153/60	6	35	200	3.46
MC-155/05	0.5	50	250	3.80
MC-155/10	1	50	250	7.60
MC-155/20	2	50	250	1.52
MC-155/30	3	50	250	2.28
MC-155/60	6	50	250	4.56
MC-155/80	8	50	250	6.08



FULLY INSULATED MINI JUMPER CLAMPS FOR SWITCHBOARD USE

These clamps are specially designed for use on energized parts in LV installations (switchboards, etc.) to make temporary connections. Isolated bronze jaws designed to axially grip conductors can be used on threaded bolts or shanks and nuts. All other models in this series tighten with T-handle screw, and receive cable terminals.

Reference	Description	(mm)	∅ (mm)	g
		Dim.	Diam.	Weight
MC-142	Adjustable clamp round	33 x 38 x 58	∅ 6-10 mm flat 5 mm.	130
MC-143	Flat bar, thickness 2-25 mm.	115 x 70 x 25	-	150
MC-145	Wire clamp for stripped cables	23 x 70 x 110	∅ 3 to 10 mm.	220
MC-146	Wire clamp for stripped cables	23 x 70 x 110	∅ 10 to 24 mm	230



MC-142



MC-143



MC-145



MC-146





FOCUS

EXPERT

PHASE INDICATOR INSULATED SCREWDRIVER 1000 V MO-65222

This 1000 V insulated screwdriver allows to locate the phase thanks to the lighting of a luminous indicator located at the end of the handle. For the phase search function, this screwdriver must be held in the hand. Operation possible with gloves.

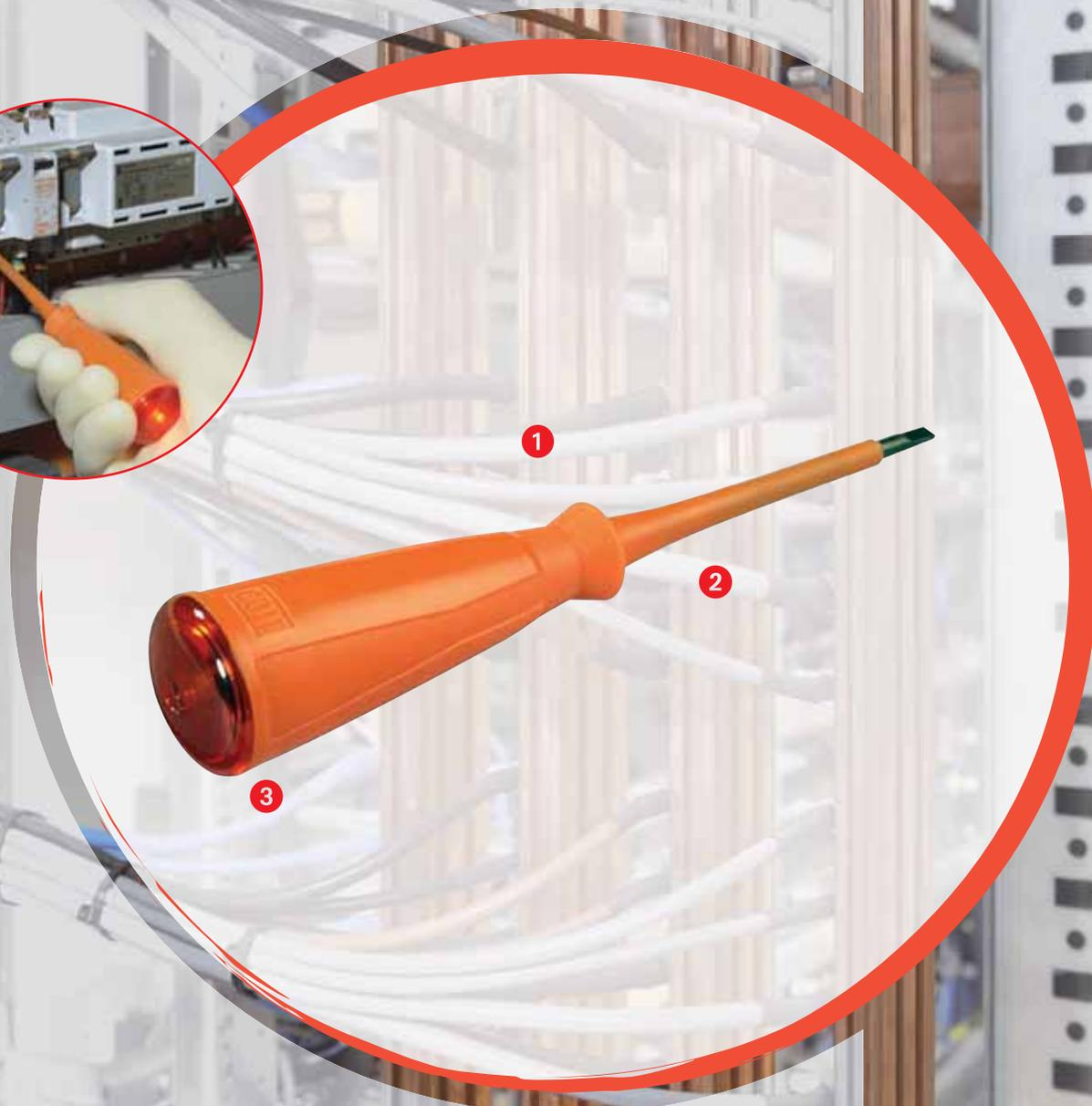

- ❶ 2 in 1: 1000 V insulated screwdriver with 4 mm flat tip with phase detection function.
- ❷ Suitable for live working. Maximum operating voltages 1 000 V AV - 1 500 V DC.
- ❸ High power flashing led the presence of a phase on the screw to be tighten or loosen.

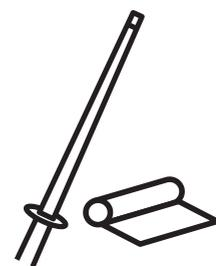

MV SUBSTATION EQUIPMENT

SAFETY EQUIPMENT	162
SUBSTATION EQUIPMENT	163
VOLTAGE DETECTORS FOR MV SUBSTATIONS	164
VOLTAGE DETECTORS FOR INDOOR AND OUTDOOR USES.....	65
TWO-POLE COMPARATORS AND PERMANENT INDICATOR.....	67
IEC SHORT-CIRCUITING AND EARTHING SYSTEM FOR MV SUBSTATION	70
CLAMPS FOR MV INSTALLATIONS ON BARE CONDUCTORS	73
FIXED POINTS FOR PERMANENT PLACEMENT	174
INSULATING STICKS.....	175
VPIS AND VDS SYSTEMS FOR MV CUBICLES.....	177
ADDITIONAL SAFETY EQUIPMENT	179
LIFE SAVING KITS	181



SAFETY EQUIPMENT KEEP YOUR SUBSTATIONS IN COMPLIANCE

SPECIAL REGULATORY SIGNALING

The standard recommends the following signaling in substations :

- A substation poster,
- Two posters about what to do in the event of an indoor or outdoor electrical emergency,
- A poster displays the service rules.

The posters are designed and supplied by CATU in kits enabling you to safely work according to the standard in your substation.



SAFETY EQUIPMENT

The standard recommends the following equipments:

- An insulating platform or an insulated mat,
- A rescue stick,
- A pair of insulating gloves adjusted to the substation's rated voltage,
- A voltage detector (see below for information)
- A grounding and short circuit device (see below for information)
- A glove box,
- A fuse holder.

CATU has assembled all of the service equipment into kits to simplify your selection and to bring your facilities into compliance right away. This equipment must include a suitable voltage detector.



INTERVENTION KITS

Reference	Characteristics
KIT-01	Intervention kit with insulating platform 24 kV
KIT-02	Intervention kit with insulating platform 36 kV
KIT-10	Intervention kit with insulating mat delivered with a protective P.V.C. container

THE KITS ARE COMPLEMENTED BY AN APPROPRIATE DETECTOR: SEE PAGE 164 TO 166.

KIT-01	KIT-02	KIT-10	Composition	Characteristics		⊠ (mm)
						Dim.
•	–	•	CG-3-10-NR	Insulating rubber gloves Class 3	26 500 V AC max	Size (10)
–	•	–	CG-4-10-NR	Insulating rubber gloves Class 4	36 000 V AC max	Size (10)
•	•	•	CG-35/2 *	Rubber gloves box	–	101 x 224 x 476
•	•	•	CI-23 *	Fuse holder	∅ max 85 mm	90 x 240 x 260
•	•	•	CS-45 **	Rescue stick	45 000 V max	Length 1.65 m
•	•	•	CI-06-D	Wall mounted supports	Delivered with CS-45	–
•	–	–	CT-7-25/1	Insulating platform	24 000 V max	500 x 500 x 220
–	•	–	CT-7-40/1	Insulating platform	40 000 V max	500 x 500 x 220
–	–	•	MP-42/16	1 insulating MAT IEC-61111 Thickness 3 mm	Class 3 - 26.5 kV	0.6 x 1 m
–	–	•	MP-20	Mat storage box	–	∅ 100 x 700 mm

* Delivered with fixations. **Delivered with wall mounted supports CI-06-D.

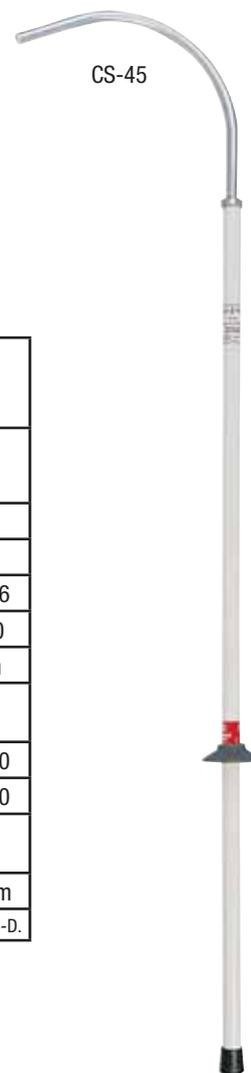

CG-35/2



CG-3-10-NR
CG-4-10-NR

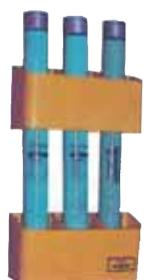

CI-23



CI-06-D



MP-20



CT-7-25/1
CT-7-40/1

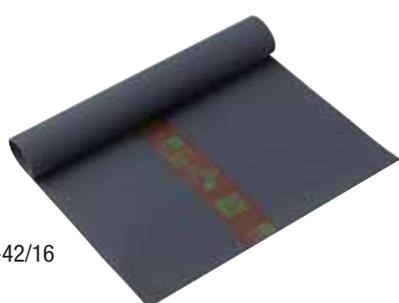

MP-42/16



VOLTAGE DETECTORS

VOLTAGE DETECTOR FOR M.V. SUBSTATION (INDOOR USE)

Built-in device for the checking operation. The indication "voltage presence" is visualized on 360° by a high brightness red LED.

High environmental resistance:

Shocks, drop, vibration. Rugged molded thermoplastic housing. External Ø 58.5 mm length (detector equipped with its insulating pole): 1.25 m.

Telescopic stick version for reduced space requirement.

Reference				
	Frequency	Folded up (m)	(m)	Weight
CL-465-10/30-M *	10 - 30 kV	-	1.35	1
CL-465-10/30-2 **	10 - 30 kV	0.75	1.18	0.9

* Delivered in vinyl sheath with wall mounting brackets CI-06-D.
** Delivered in canvas bag, waterproofed with ramp.

BENEFITS

- Battery lifetime : above 8 years.
- The indication "voltage presence" is visualized on 360°.

VOLTAGE DETECTOR FOR CAPACITIVE TERMINALS OF ELBOW MV CONNECTOR

In compliance with the standard SPS EDF N° 42. Maximum operating network voltages: 30 kV . Rated voltage max. : 36 kV.

Note: This detector is directly positionned on networks but behind a capacitive divider. Recommended insulating stick : CC-45-K (length: 1,25 m).

Reference	Characteristics		
		Dimensions	Weight
CC-161-K*	Voltage detector for test points of the separable connectors networks from 10 to 30 kV	130 x 180 x 40	0.82
CC-162-K*	Voltage detector for test points of the separable connectors networks from 3 to 36 kV.		
CC-45-K	Insulating stick 45 kV.	1.25 m	0.6

* Device delivered in hard shell case.



IEC 61243-1
CE



CL-465-10/30-M

CL-465-10/30-2



EDF SPS 42
CE



CC-45-K
(recommended stick)

IEC ELECTRONIC VOLTAGE DETECTORS (MV), "COMPACT SERIE" FOR INDOOR AND OUTDOOR USE

Ultimate technology of voltage detector "Head Capacitive Technology"

Compact and light, it offers a wide band (10/36 kV).

Operating check

By pressing the TEST button:

- A RED LED flashes on.
- Powerful rated audible signal > 67 dB(A)/2 m.
- When loosening the button, the timed GREEN LED lights up. While remaining on, it indicates the good working order of the detector.

Characteristics

- Precise and stable operating threshold.
- High environmental resistance (impacts, vibrations, moisture).
- Temperature conditions: class N (IEC 61243-1 standard).
- Use from 50 to 60 Hz.

Composition

- Robust housing.
- Weight: 350 g.
- Dimensions: Ø 59 x 270 mm.



IEC 61243-1 :2003+ AC1: 2005 +A1: 2009



CC-765...C
End fitting C

CC-765...K
End fitting K

CC-775 : 2 voltage ranges detector, in compliance with IEC 61343-1

Reference	1st voltage range		2nd voltage range	
	Un min (uu)	Un Max (vv)	Un min (xx)	Un Max (yy)
CC-775-2/7-12/25-(*)	2 kV	7 kV	12 kV	25 kV
CC-775-2/72:12/36-(*)	2 kV	7.2kV	12 kV	36 kV
CC-775-2/72-34/115-(*)	2 kV	7.2 kV	34 kV	115 kV
CC-775-33/11:22/66-K	3.3 kV	11 kV	22 kV	66 kV
CC-775-4/14-24/69-K	4 kV	14 kV	24 kV	69 kV
CC-775-4/144-25/69-K	4 kV	14.4 kV	25 kV	69 kV
CC-775-47/15-25/69-K	4.7 kV	15 kV	25 kV	69 kV
CC-775-6/12-22/66-C	6 kV	12 kV	22 kV	66 kV
CC-775-11/22-33/66-K	11 kV	22 kV	33 kV	66 kV
CC-775-12/24-52/132-(*)	12 kV	24 kV	52 kV	132 kV

(*) End fitting : C or K

BENEFITS

- Results visible over 360° with a powerful light. Voltage range pre-selected to your application.

Reference		Operating voltage		
	Frequency		Type 6 LR-61	Weight
CC-765-2/72-(*)	50/60 Hz	2 - 72 kV	9 V	0.35
CC-765-3/10-(*)	50/60 Hz	3 - 10 kV	9 V	0.35
CC-765-5/18-(*)	50/60 Hz	5 - 18 kV	9 V	0.35
CC-765-5,5/20-(*)	50/60 Hz	5.5 - 20 kV	9 V	0.35
CC-765-10/30-(*)	50/60 Hz	10-30 kV	9 V	0.35
CC-765-10/36-(*)	50/60 Hz	10 - 36 kV	9 V	0.35
CC-765-11/33-(*)	50/60 Hz	11 - 33 kV	9 V	0.35
CC-765-15/45-(*)	50/60 Hz	15-45 kV	9 V	0.35
CC-765-20/66-(*)	50/60 Hz	20 - 66 kV	9 V	0.35
CC-765-30/66-(*)	50/60 Hz	30 - 66 kV	9 V	0.35
CC-765-44/132-(*) ⁽¹⁾	50/60 Hz	44 - 132 kV	9 V	0.35
CC-765-63/90-(*) ⁽¹⁾	50/60 Hz	63 - 90 kV	9 V	0.35

(*) Specify type of mounting when ordering: C or K.
 (1) supplied with 1 hook-shaped contact electrode CC-ANT 120 (Ø120 mm).
 Packaging: unit supplied complete in a case with batteries and contact electrodes (straight and V-shaped).
 For other voltages, please consult us.



C K

End fittings:

C: hexagonal 12 mm, for hexagonal end-fitting sticks,
 K: universal, for universal end-fitting sticks.
 Recommended stick:
 CE-4-21, CE-75, CE-9.





VOLTAGE DETECTORS

IEC ELECTRONIC VOLTAGE DETECTOR WITH PROBE, FOR INDOOR AND OUTDOOR USES

IEC 61243-1 :2003+ AC1: 2005 +A1: 2009



Ultimate "head capacitive technology" of voltage detector.

- Universal application 50 / 60 Hz and wide band of voltage from 5 to 30 kV.
 - Type S (Substation) with electrode extension.
- The electrode extension is designed to ensure no inside failure.
- Equipped with its insulating stick : Assembly by screwing.

Voltage presence is indicated by:

- RED flashing LED (very bright, visible at more than 20 m in direct lighting).
- Powerful rated audible signal > 67 dB (A) / 1.5 m.

Characteristics:

- Temperature conditions: class N (-25 to 55°C).
- Type S (with electrode extension).
- Electrode extension diameter : 14 mm.
- Power supply: 1 standard 9 V battery 6LR61.
- Network frequencies : 50 and 60 Hz.
- Contact electrodes fitted by screwing and easily interchangeable.
- Packaging: supplied in a carrying bag with zip (930 mm x 200 mm) and transparent side pocket (CM-1-10).
- CE marking complies with EMC immunity regulations.

NEW



Reference	Characteristics			
		Frequency	(m)	Weight
CC-965-10/30	With stick and probe	10 - 30 kV	Length: 1.55 m Diameter: 59 mm	850
CC-965-5/15	With stick and probe	5 - 15 kV	Length: 1.45 m Diameter: 59 mm	820
CC-965-5/15-C	With probe	5 - 15 kV	Probe length: 590 mm	530
CC-965-10/30-C	With probe	10 - 30 kV	Probe length: 690 mm	530
CC-965-10/30-K	With probe	10 - 30 kV	Probe length: 690 mm	530

Accessories

Reference	Characteristics
M-78723	Plastic carrying case
CM-1-10	Canvas bag



BENEFITS

- 360 ° light indication.
- Delivered in a waterproof canvas bag.
- With insulating stick.

TWO-POLE PHASE COMPARATORS FOR INDOOR USE

The DETEX CL-8-36 detects differences in voltage between any two points of an installation indicated by LED's. It also enables assessment of the order of magnitude of the residual voltage induced by nearby live lines or circuits, and thus differentiates it from the one provided directly from a high voltage source.

Two 1.25 m elements with removable probes, connected via a high-insulation lead.

High dielectric quality insulating material.

Reference	Voltage (AC)	dimension		kg
		assembled	dismantled	
CL-8-36	2 to 36 kV	1.25 m	0.62 m	1.1
CL-8-36/1 *	2 to 36 kV	1.25 m	0.62 m	1.3
* As CL-8-36 tester with 2 probes extenders 0.55 m. Câble 1.5 m for CL-8-36 and 3 m for CL-8-36/1. Delivered in plastic case.				

Accessories

Reference	Characteristics
C-92-20	Spare probe 0.550 m
CL-8-05	Probe extenders 0.550 m



CE

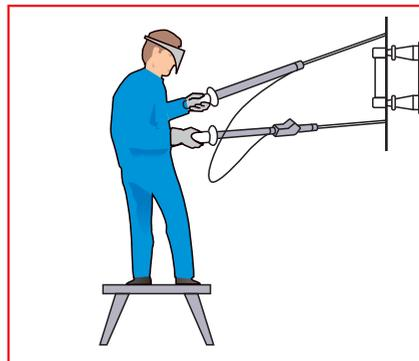

Checking a H.V. fuse.

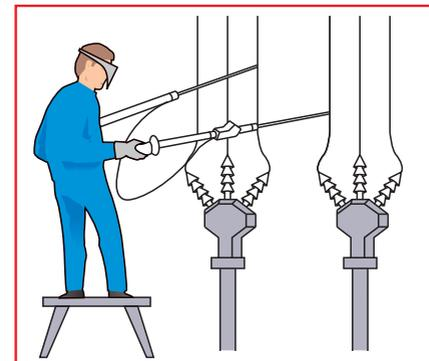

Checking for phase matching. CT-7-40/1



OPERATING TESTERS

To perform mandatory testing on the controllers before and after each use.

Reference	Characteristics	Voltage	mm	kg
			Dim.	Weight
CL-1-06	Delivered in case with lead	Adjustable 10, 20, 30 kV	190 x 32 x 65	0.32



Unlike single-core voltage testers, dual core testers can recognize potential differences between any two points in an MV installation. Primarily reserved for conductors of the same phase (matching), they can also be used for dual core detection and for testing MV fuses.



PERMANENT INDICATOR

PERMANENT LUMINOUS INDICATOR FOR INDOOR USE

Single-pole 5 to 75 kV indicator. On bus bars. Rings with Ø 5 to 20 mm and planes 1 to 20 mm. Fixing on conductors. Signaling the presence of voltage by 7 electroluminiscent diodes.

Reference	Characteristics
CL-40010	Sold in box of 3 units

BENEFITS

- Flexible stem for adjusting the orientation of the LEDs.



BIPOLAR VOLTAGE DETECTOR FOR DIRECT VOLTAGE

Application :

- Bipolar DC voltage detector: 100 V to 30 kV DC.
- The low threshold set to 100 V makes it possible to detect any voltage exceeding the limits of the low voltage DC.
- Indoor use (Use only on laboratory and workshop type installations).

Characteristics :

- Voltage presence indicated by:
- Lighting of 6 red diodes.
- Acoustic signal (60 dB (A) / 2 m).
- 380 mm contact electrode.
- Overall length of the detector: 840 mm.
- Indication group: III.

Composition:

- 2 elements with removable probes, connected by a cable.
- 1 transport case.

Mechanical and dielectric tests

Compliant with NF EN 61243-2



Reference		Contact electrode		
	DC Voltage		Length (cm)	Weight
CL 6-120-5000 *	120-5 000 V	ANTP	910	1.5
CL 6-100-30000**	100-30 000 V	ANTP	910	1.5

*Delivered in a heavy duty plastic case.
** Delivered in a heavy duty plastic case with 2 types of electrodes (tulip and tapered).

- Total length: 1.075 m.
- Probe length: 350 mm.
- Cable length: 1.9 m.
- Weight complete device: 2 kg.



In some cases, our equipment must be adapted according to customers specifications to fit to fit specific applications, and installation or structure types.

CATU has developed a «Flexible Workshop» on its production site dedicated to manufacture customized solutions answering your needs. Our experts carry out a pre-production feasibility study and send you a quote quickly.

Our «Flexible Workshop» Team can quickly provide support on:

SPECIFIC MANUFACTURING

- Earthing and short-circuiting;
- Adaptation of medium and high voltage detectors.

TROUBLESHOOTING

- According to product specificity and quotation;
- With guaranteed speed.



To contact our experts:

Charles Saulnier

charles.saulnier@catuelec.com

Phone: +33(0)1 42 31 63 10

Corinne Peigne

corinne.peigne@catuelec.com

Phone: +33(0)1 42 31 46 24

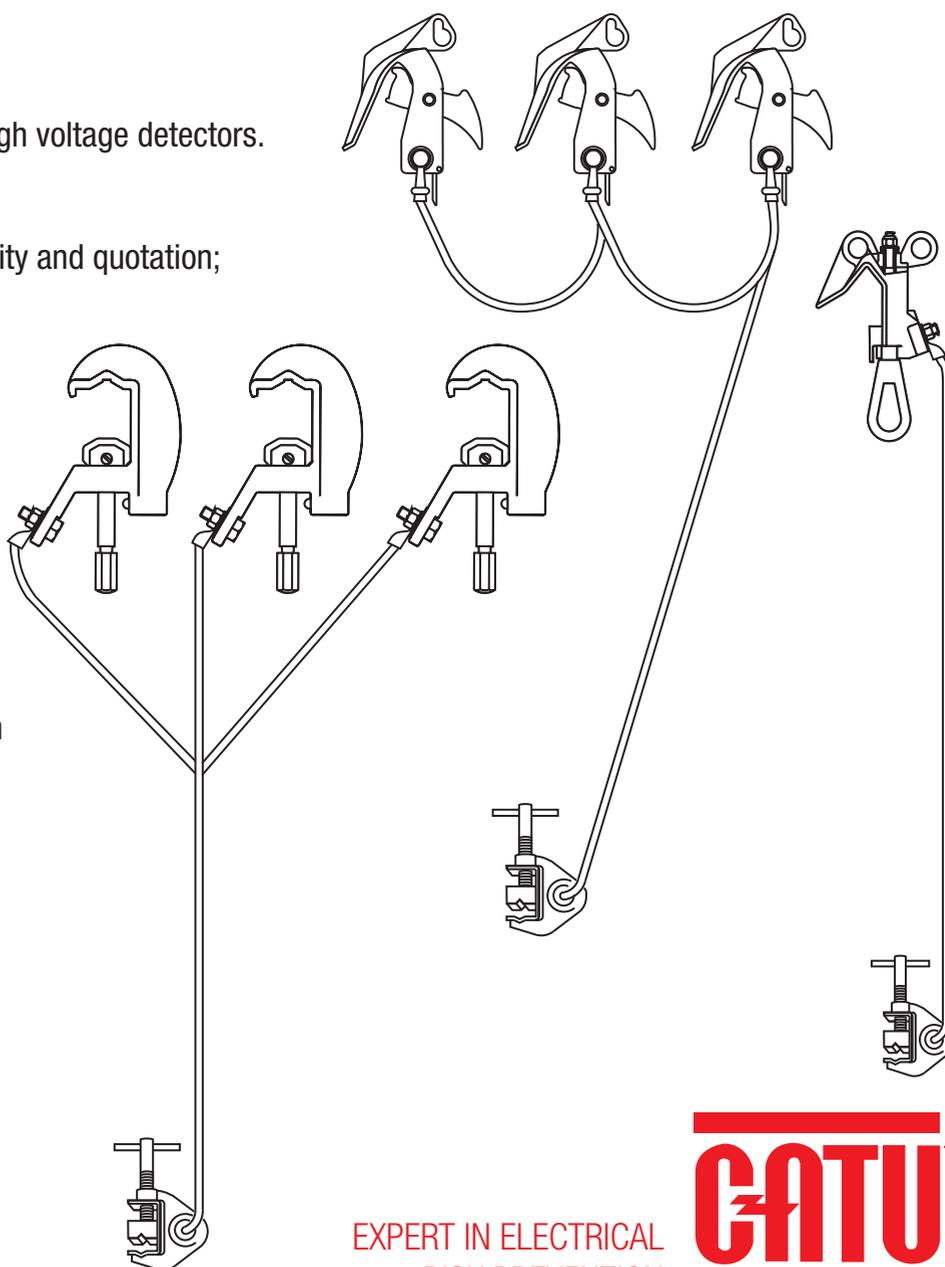

EXPERT IN ELECTRICAL
RISK PREVENTION

CATUTM

SICAME GROUP

CATUTM

EARTHING AND SHORT-CIRCUITING DEVICE FOR FIXED POINTS

Composition:

- 3 x mini clamps
- 3 x Extra-flexible copper cables with PVC insulation
- 1 x Trifurcation connector
- 1 x Earth Cable in extra flexible copper cable with PVC insulation
- 1 x Earth clamp
- Case
- User guide

Reference	Rating (kA/1 s)	Installation on fixed points (mm)	Composition	Connection set
MT-1910-EP	20	Ø 20 MT-2951 range	3 clamps MT-1911-E 1 MT-1911	3 cables 95 mm ² 1 earth cable 35 mm ²
MT-1920-EP	30	Ø 25 MT-3951 range	3 clamps MT-1921-E 1 MT-1921	3 cables 150 mm ² 1 earth cable 50 mm ²
MT-1920/1EP	40	Ø 25/30	3 clamps MT-1921-E1 1 MT-1921/1	3 cables 150 mm ² 1 earth cable 50 mm ²

Fixed points
(characteristic page 174.)



Ø 20 mm

Ø 25 mm



Plastic case M-78665

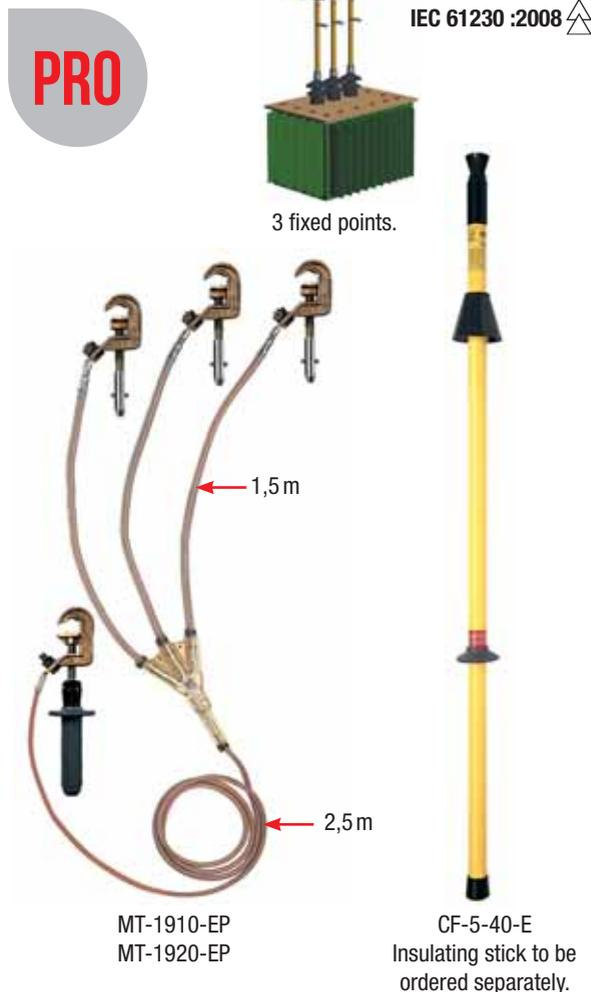

MT-1910-EP
MT-1920-EP

CF-5-40-E
Insulating stick to be ordered separately.

EARTH CLAMPS

Clamps for "T" or spherical fixed points.

Reference	Characteristic	Rating (kA/1 s)	
			Weight
MT-1911-E	Claw for "T" fixed points Ø 20 mm round conductors Ø 8 to 18 mm	20	580
MT-1921-E	Claw for "T" fixed points Ø 25 mm round conductors Ø 10 to 25 mm	40	690
MT-1911	Same characteristics with handle MT-1911-E	20	-
MT-1921	Same characteristics with handle MT-1921-E	40	-
M-9573	Handle alone C end fitting	-	-



MT-1911-E
MT-1921-E

MT-1911
MT-1921

IEC SHORT-CIRCUITING AND EARTHING SYSTEMS FOR MV SUBSTATIONS



INSTALLATION ON BARE CONDUCTORS

3 clamps. 3 copper extra flexible cables with silicone sheath.
L = 1.5 m. 1 trifurcation connector earthed by an extra-flexible copper cable with silicone sheath, L = 2.5 m. Earth clamp.



IEC 61230 :2008

Reference	Rating (kA/1 s)	Stick	Composition	Connection set	Installation on fixed points	
						Weight
MT-5805	20	MT-830-P	3xMT-815-C 1xMT-840/1	3 cables 95 mm ² 1 earth cable 35 mm ²	• Ø 5-35 — 16-40 5-40	8
MT-8408	12.5	MT-830-P	3 x MT-814/3 1 x MT-840/1	3 cables 70 mm ² 1 earth cable 35 mm ²	• Ø 18-33 — 	10
MT-9801	10	MT-830-P	3 x MT-817-C 3 x MT-814/2 1 x MT-840/1	3 cables 50 mm ² 1 earth cable 25 mm ²	• Ø 5-16 — 0-16 • Ø 5-28	11

Delivered in case. Clamp characteristics : see page 173.

Installation on permanent fixed points:

Reference	Characteristics
MT-890	Clamps 3 claws
MT-891	Earth clamp fixation
MT-893	Cable tensioner
MT-895	Cable kit support
CI-06-D	Wall mounted support

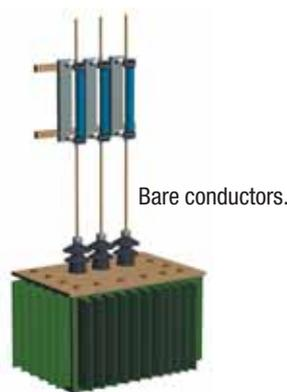

Bare conductors.



Plastic case included.
M-78665



MT-4804-P

Plastique case included M-78691.



CE-4-21-C
Insulating stick to be ordered separately.



IEC SHORT-CIRCUITING AND EARTHING SYSTEMS FOR MV SUBSTATIONS

EARTH CLAMP WITH SECURITY PADLOCK

Increase Safety with an Exclusive CATU Solution to avoid forgetting the earthing equipment in place before switching on the voltage again. The earth clamp and the padlock use the same unique key. When the earth clamp is in place, the key can't be removed from the clamp. Switch off the electric generator and lock the installation using the locking padlock. The key, coming from the padlock, is then used to lock out the earth clamp which can then be fixed to the earth connection point. The key is then trapped on the earth clamp. The electric generator can't be switched on with the earth clamp in place. When the earthing and short-circuiting operation is over, the first step to take off the equipment is to unscrew the earth clamp in order to free the key. Finally, the key is used to unlock the padlock and switch on the electric generator again.



IEC 61230 :2008

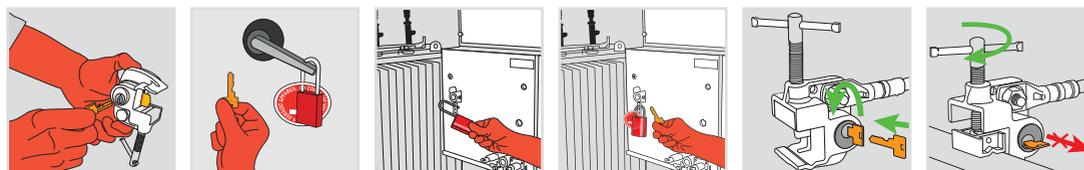

Reference	Rating (kA/1 s)	Dimensions (mm)	Clamping capacity (mm)		Weight (kg)
		Dimensions	Clamping capacity		Weight
MT-870	20	70 x 90 x 50	∅ 6-26 mm flat 0-30 mm	Aluminium, 6,5 mm shackle, unique key	1

EARTHING AND SHORT-CIRCUITING DEVICE FOR BARE CONDUCTORS WITH SECURITY PADLOCK

Composition:

- 3 X conductor clamps
- 3 X Extra-flexible copper cables with PVC insulation
- 1 X Trifurcation connector
- 1 X Earth extra-flexible copper cable with PVC insulation
- 1 X Lockable earth clamp with security padlock
- 1 X Unique key
- Carrying case
- User guide



MT-1911-E1



Bare conductors.



Plastic case included.



IEC 61230 :2008

CE-4-21-C
Insulating stick to be ordered separately.

Reference	Rating (kA/1 s)	Fixed points	Capacity (mm)	Clamps and earthing clamp composition	Connexion cables	Dimensions (mm)	Weight (kg)
						Dim. case	Weight
MT-5805/870	20	MT-830-P	<ul style="list-style-type: none"> • ∅ 5-35 ■ 16-40 ■ 5-40 	3 high capacity clamps MT-815-C 1 paired clamp/padlock MT-870	3 x 70 mm ² 1 x 35 mm ²	650 x 480 x 210	8
MT-1910/870	20	∅ 20 and 25	<ul style="list-style-type: none"> • 5 à 20 ■ 20 	3 fixed-point clamps 1911-E1 1 paired clamp/padlock MT-870	3 x 70 mm ² 1 x 35 mm ²	650 x 480 x 210	8

For any customized solution, please contact our Flexible Workshop Team:
Phone : +33(0)1 42 31 63 10
+33(0)1 42 31 46 24



CLAMPS FOR INSTALLATION ON BARE CONDUCTORS

IEC 61230 :2008

Attachment (C-Type)

Hexagonal end-fitting. The clamp from turning under the weight of the cable. Separate by simple pulling. Earth cable connection. With a crimped lug (12 mm Ø hole).

Material

Aluminium alloy except **MT-814/2** and **MT-814/3**: copper-aluminium bronze.

Reference	Rating (kA/1 s)	Dimensions (mm)	Ø (mm)	Weight (g)
		Dimensions		
MT-814/2	14.5	85 x 56 x 192	• Ø 5/328	660
MT-814/3	14.5	85 x 56 x 195	• Ø 18-33	620
ZEMCC-2851-H	14.5	56 x 85 x 192	• Ø 5-34	660
MT-812-C	21	35 x 79 x 143	• Ø 5-16 — 0-16	320
MT-815-C	30	44 x 100 x 180	• Ø 5-35 — 16-40 5-40	600
MT-815-S				
MT-815-1/C				
MT-815-E				

Recommended stick:
CE-4-21-C / CF-3-72 ou E

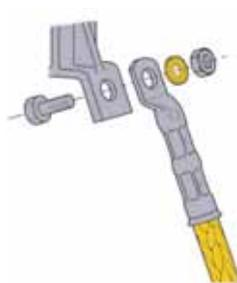

Attachment C:
6-point female attachment with safety ball. Prohibits the clamp from turning on the pole.

Bayonet end-fitting.



MT-812-C



MT-814/2
MT-814/3
ZEMCC-2851-H



MT-815-C



MT-815-1/C



EARTH CLAMPS

Copper aluminium bronze earth clamps.
Earth cable connection by connector, lug, T0- system...

Reference	Rating (kA/1 s)	Dimensions (mm)	Connection	Clamping capacity (mm)	Weight (g)
		Dimensions		Clamping capacity	
MT-840/1	20	40 x 73 x 135	Thread: Ø 12.5 mm	• Ø 6-25 — 0-25	380
MT-841	30	40 x 73 x 135	Connect. Fontenay ≤ 50 mm ²	• Ø 6-25 — 0-30	380



MT-840/1



MT-841



SHORT-CIRCUITING AND EARTHING SYSTEMS (INSTALLATIONS)

FIXED POINTS FOR PERMANENT PLACEMENT

The advantages of grounding and short circuiting using permanently installed fixed points on existing conductors include:

- Using the same grounding and short circuiting equipment regardless of the conductor shape, section, or configuration.
- Accessibility from variable angles.
- Eliminating the risk of errors because grounding locations appear at first glance.

Reference	Rating (kA/1 s)	Sphere dimension Ø	Fixing	Fixing	g	
					Weight	
MT-951/1	10	18 mm	Bolt: M 10 - L = 25 mm	Flat conductors	90	
MT-951/2			Bolt: M 10 - L = 35 mm		100	
MT-951/3			Bolt: M 10 - L = 45 mm		100	
MT-952/1			Bolt: M 10 - L = 25 mm		110	
MT-952/2			Bolt: M 10 - L = 35 mm		120	
MT-952/3			Bolt: M 10 - L = 45 mm		130	
MT-953/08			Ø 6-8	Round conductors	130	
MT-953/12			Ø 10-12		180	
MT-955/08			Ø 6-8		150	
MT-955/12			Ø 10-12	200		
MT-956				12.5 mm drilling	Terminal fitting	750
MT-2951			20	20 mm	M12 thread	-
MT-2951/1	Bolt: M 12 - L = 35 mm	180				
MT-2951/2	Bolt: M 12 - L = 45 mm	200				
MT-2950/35	Bolt: M 12 - L = 45 mm	240				
MT-3951	30	25 mm	M12 thread	-	240	
MT-3952			M16 thread		240	
MT-3951/1			Bolt: M 12 - L = 45 mm		300	
MT-3952/1			Bolt: M 16 - L = 45 mm		350	
MT-3950/35			Bolt: M 12 - L = 35 mm		300	



MT-2951
MT-3951
MT-3952

MT-2950/35
MT-3950/35

MT-2951/1
MT-2951/2
MT-3951/1
MT-3952/1

ACCESS POINTS

To be used with clamps type MT-1911, MT-1921.

Reference	Rating (kA/1 s)	Fixing	kg
			Weight
MT-1951/10	20	Bolt: M 10 - L = 35 mm	0.12
MT-1951/12	20	Bolt: M 12 - L = 35 mm	0.12

Clamps

Reference	Rating (kA/1 s)	Fixing	kg
			Weight
MT-920-E	20	For fixed points Ø 20 mm	0.35
MT-925-E	20	For fixed points Ø 25 mm	0.40



INSULATING STICKS FOR SUBSTATION

Telescopic sticks for voltage detectors and earthing systems for use in dry and wet conditions.

Reference	~	∅ (mm)	↔	↔	kg
	Operating voltage (kV)		(m) Folded	(m) Unfolded	
CE-75-(**)	75	41/32	1.15	2	1.3
CE-4-21-(*)	90	41/32	1.15	2	1.5
CE-4-30-(*)	150	41/32	1.75	3	2
CM-7-10-A	Extension	36	-	1	1

(*) Specify type of mounting when ordering : C, K or E.
(**) Specify type of mounting when ordering : C or K.

Reference	~	∅ (mm)	↔	↔	kg
	Operating voltage (kV)		(m) Folded	(m) Unfolded	
CE-5-105-X	220	63.5/27.5	1.66 m	10.75 m	5.4
CE-5-90-X	220	57.5/27.5	1.61 m	9.25 m	4.2
CE-5-70-X	220	52.5/27.5	1.56 m	7.8 m	3.3
CE-5-60-X	220	47.5/27.5	1.51 m	6.4 m	2.5
CE-5-50-X	220	42.5/27.5	1.46 m	5 m	1.9

X : Specify type of mounting when ordering.
(K : universal ; C : hexagonal, 12 mm across the flats).

BENEFITS

- CE-4-21-(*) and CE-4-30-C : Certified telescopic rod IEC 62193 (2003) and IEC 61235. Hand guard. CE-75-(*) : Certified telescopic rod IEC 62193 (2003) and tube IEC 60855-1. CE-75-C : Enedis authorisation: 18-130 B.
- CE-5-(**) : Certified telescopic rod IEC 61235.

STANDARD STICKS

For short circuiting and earthing system. For use in dry conditions.

Reference	~	∅ (mm)	↔	kg
	Operating voltage (kV)		Length (m)	
CF-3-72...-(*)	72.5	41/32	1.50	0.88

(*) Specify type of mounting when ordering : C, K or E. Delivered with wall mounting CI-10-D

STICK WITH SKIRT

For short circuiting and earthing system. Epoxy resin / fiberglass composite tubes, foam-filled with polyurethane. With polycarbonate insulating skirt ∅ 100 mm, height 90mm, impact resistant. Use in dry and wet conditions.

Reference	~	∅ (mm)	↔	kg
	Operating voltage (kV)		Length (m)	
CF-5-90-(*)	90	36	2	1.55

(*) Specify type of mounting when ordering : C, K or E.

PRO

Upper foam-filled element made of glass fiber / epoxy resin, diameter 32 mm



CM-7-10-A
Shock resistant terminal insulating element, made of foam-filled glass fiber and polyester resin.

Stick bags see page 176



INSULATING STICKS

FIX STICKS

For substation earthing and short-circuit equipment. For indoor use only.

Reference		Ø (mm)	 (m)	 Weight
	Operating voltage (kV)			
CF-3-72...-(*)	72.5	36	1.50	0.88

(*): At the order, mention the type of end fitting : C, K or E.

STATIC DISCHARGE STICK

CM-50 STANDARD MODEL

For use on medium voltage lines up to : 33 kV. Insulating orange tube Ø 39 mm made of epoxy fiberglass and in accordance with IEC 60855 standard. Fitted with 6 m copper cable, cross-section 6 mm², PVC insulated. Hand guard at length 0.65 m. Copper alloy contact probe, length: 80 mm.

Reference		 (m)	 Weight
	Operating voltage (kV)		
CM-50	33	1.6	2.3

CI-15-D	Wall mounted support, see page 180.
---------	-------------------------------------

CUSTOMIZABLE MODELS

On request, it is possible to design a set which will fit your existing sticks.

Hook type	CM-05-K	CM-03-K + adaptator CI-4-K
Stick	Fix or telescopic	
	End fitting K	End fitting C
Cable	Cross-section and length to be defined according to your need.	
Earth clamp	MT-840/1	

For any request, please contact our technical department

INSULATING STICK COVERS

For storage and transport. Waterproof canvas and zipper closure.

Adjustable straps. Transparent pocket for identification.

CM-1-...: for 1 to 3 poles.

CM-3-...: for CM-6 series or 5 simple elements or 4 double elements.

Reference	 (mm)
	Dimensions
CM-1-10	1.30 m Length
CM-1-15	1.80 m Length
CM-1-20	2.40 m Length
CM-3-03	0.575 x 1.950 m (elmt 1.75 m length)
CM-3-04	0.575 x 2.450 m (elmt 2 m length)
CM-3-05	0.575 x 2.850 m (elmt 2.50 m length)
CM-3-06	0.575 x 3.400 m (elmt 3 m length)



CF-3-72-C

CM-50

CM-03-K

CI-4-K

CM-05-K

MT-840/1

CE-4-21-C
+ CI-4-K
+ CM-03-K

CF-5-40-K
+ CM-05-K

CM-1-20

CM-3-03

We can deliver complete set with foot capacitance, head capacitance and wirings to your own specifications. Please consult us.

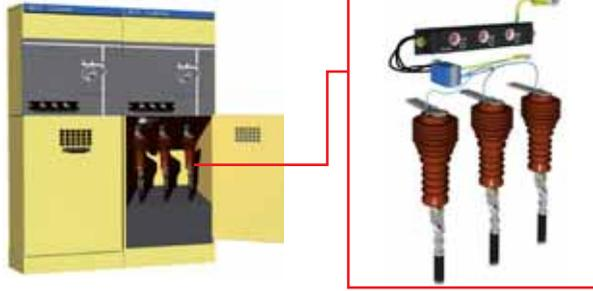

INTEGRATED VOLTAGE PRESENCE INDICATING SYSTEM (V.P.I.S)

IEC 62271-206

Indicates the voltage presence on M.V. cubicles by being installed on the capacitive dividers. Voltage of use behind capacitive dividers: 1 000 V (between phase and neutral). Light threshold: 90 V. Signaling: 3 neons. Attachment: male/female plugs. Sound phase comparator. **MX-404**.

Reference	Characteristics	 (mm)	 kg
		Dimensions	Weight
CL-495-3	Delivered complete with connector assembly	130 x 30	0.85

ALL ORDERS MUST BE VALIDATED BY CATU.



INTEGRATED VOLTAGE DETECTING SYSTEM (V.D.S)

IEC 61958 

Indicates the voltage presence on M.V. cubicles by being installed on the capacitive dividers. Voltage of use behind capacitive dividers: 1 000 V (between phase and earth). Light threshold: 70/90 V. Input impedance: 36 MΩ. Signalling by 3 red diodes. Sound phase comparator.

Reference	Characteristics	 (mm)	 kg
		Dimensions	Weight
CL-497-00	Delivered complete with connector assembly	146 x 30	0.90

ALL ORDERS MUST BE VALIDATED BY CATU.



SOUND PHASE COMPARATOR***

The MX-404 sound phase comparator checks the concordance between 2 phases. The comparator's operation is indicated by: Emission of an audible signal when there is discrepancy between the two phases. Absence of an audible signal when there is no discrepancy between the two phases. Power supply: 9 V type 6LR battery.

Reference	Characteristics	 (mm)	 kg
		Dimensions	Weight
MX-404 ***	Delivered with case	145 x 80	0.90

*** This comparator does not work on Schneider electric cells V2 type.



ALL ORDERS MUST BE VALIDATED BY CATU.



INTERFACE FOR INTEGRATED VOLTAGE DETECTING SYSTEM (V.D.S)

*IEC 61243-5 

Indicates the voltage presence on M.V cubicles by being installed on the capacitive dividers. For High impedance detecting systems Input impedance: 36/43 MV. Voltage indication by 4 mm standard sockets on the front of the indicator. Voltage indicator by 4 mm standard socket at first glance.



Reference	Characteristics	 (mm)	 kg
		Dimensions	Weight
CL-498-00*	Delivered with connection set	145 x 30	0.90

ALL ORDERS MUST BE VALIDATED BY CATU.

SEPARABLE VOLTAGE DETECTING SYSTEM (V.D.S)

This device enables to check the absence or presence of voltage on three phases (L1, L2, L3). HR high impedance. Voltage max: 1 080 V rms. 50/60 Hz. Voltage presence: RED flashing LED > 1 Hz. Fits in CL-498 devices.



Reference	Characteristics	 (mm)
		Dimensions
CL-499/101	Delivered in plastic bag	145 x 30

ALL ORDERS MUST BE VALIDATED BY CATU.

VOLTAGE TESTER FOR M.V. SEPARABLE CONNECTORS 10-36 KV

Checks the absence of voltage on the capacitive terminals of plug-in M.V. bushings. Sensor in the form of a bent finger enabling removal and reinstallation of the terminal insulating cover. For a nominal voltage from 10 to 30 kV or from 3 to 36 kV (depends on model). Signal via beeping and bright red flashing of electro-luminescent diodes. Built-in function test via the «TEST» button which covers the entire device. Permanent stand-by state. Power supply: four 1.5 V, R-6 batteries. Recommended insulating stick : CC-45-K.

SPS EDF n° 42
EMC Directive n°2014/30/UE



Reference	Characteristics	 kg
		Weight
CC-161-K	For 10 to 30 kV networks	0.82
CC-162-K	For 3 to 36 kV networks	0.82
CC-45-K	Insulating stick 45 kV with universal end. Length 1.25 m	0.6



SAFETY LAMPS

Compatible with NF C 13-100.

Reference	Characteristics	(mm)	kg
		Dimension	Weight
CD-128	2 operating modes: BAPI (factory setting) or BAES (automatic mode is triggered during power cut) 1 LED 1W white Autonomy 1 H to 3 H depending on the position of the switch 45 lm / 3 H: 1st support / 100 lm / 1 H: 2nd support In compliance with the standard BAPI NFC 71810 Battery Ni Cd 1 battery 2.4V 1.5Ah - Power supply 230V - 50 / 60HZ Operating Temperature 0 °C to + 40 °C Protection indices IP42 and IK10 I - Class II	240 x 138 x 60	0.68
CD-124	Delivered with a wall mounted support. Operates: 1 hour (12 W), 2 hours (6 W) Rechargeable on 230 V 50/60 Hz	100 x 190 x 220	1.9



CD-128



CD-124



BENEFITS

- 100% LED
- up to 3 hours of battery life
- Small and very light
- Adjustable handle.

MANŒUVERING AND RESCUE STICKS

White resin polyester/glass fiber foam filled tube.

Reference	Icc (kV)		kg
		(m)	Weight
CM-45	45	1.50	0.75
CS-45*	45	1.70	1.00
CS-45/2**	45	1.70	1.00
CS-90*	90	2.05	1.10
CS-225*	225	2.45	1.35

* Delivered complete with non-removable hook and wall supports.
 ** Delivered with a non removable insulated hook.
 Cannot be used in rain.

PRO

NEW

NEW

CM-45

CS-45

CS-45/2



ADDITIONAL SAFETY EQUIPMENT

APERTURE HOUSING

Compatible with NF C 13-100. Moulded plastic. Installed outside by tightening three screws on a steel clamp.

Reference	Passage	
		Weight
CI-70	60 mm	140



WALL MOUNTED SUPPORTS

For sticks and voltage detectors. Plastic.

Reference	Recommended sticks	Ø (mm)	
		Top	Bottom
CI-08	CE-2	16-20	36 max
CI-06-D	CS-45, CS-90, CS-225	28-30	36 max
CI-12-D	MT-830P	28-30	58 max
CI-10-D	CE-421, CE-430, CF-372, ZPLET	32-36	58 max
CI-15-D	CM 4600 serie	39	58 max
CI-18-D	CM-6, CE-5	42-48	58 max



RESCUE HOOK

On stick equipped with a «C» end-fitting. Delivered with wall mounted supports.

Reference	Characteristics		
		Dimension	Weight
CS-01-C	Adaptor C	345 x 335	350



LIFE SAVING KITS FOR M.V. SUBSTATIONS

Complete equipment allowing intervention on victims in case of an electrical hazard. Delivered in a plastic box with transparent cover for immediate visualization of contents and wall mounting kit.

Composition :

- Insulated cable cutter. Forged steel blades. Maximum opening 30 mm. (CZ-60)
- Insulating platform 24 or 36 kV. (CT-7-25/1)
- Rescue telescopic stick. (M952160)
- Voltage detector with flexible antenna contact (with autotest). (M952170)
- Safety instructions on the plastic board. (CG-3-10-NR/CZ-54)
- High voltage insulating gloves, talcum powder can. (CG-4-10-NR/CZ-55) - (CG-3-10-NR/CZ-54)
- Insulating boots. (MV-137-45)
- Wall mounted cabinet.



Reference	Characteristics	Icc (kV)	Dimension (mm)	kg
			Dimension	Weight
CZ-54	English instructions	24	840 x 754 x 270	21
CZ-54-FM	English/Arabic instructions	24	840 x 754 x 270	21
CZ-55	English instructions	36	840 x 754 x 270	21
CZ-55-FM	English/Arabic instructions	36	840 x 754 x 270	21

Pour versions avec affiches dans d'autres langues, nous consulter.

BENEFITS

- Emergency supplies at your fingertips.
- Protection against dust and shock.

INFO

In case of an electrical accident, quick action is essential: by saving seconds, you get more chance to save life. Our life saving equipment is designed to make all necessary equipment immediately available to rescue people.

INSULATED CABLE CUTTER

Insulated handles 25 kV. Maxi cable : 30 mm. Section ≈ 150 mm². Maximum opening: 30 mm.

Reference	↔	kg
	(m)	Weight
CZ-60	0.63	2.2





COMPACT CARRYING KIT

This compact kit is designed especially to be carried in a vehicle for safety electrical intervention. Made of two parts of moulded material (PEHD), the red case cover is also an insulating platform.

Composition :

- Insulated cutter cable.
- Adhesive tape (black and yellow). L = 100 m.
- Telescopic insulating stick. L = 1.5 m.
- Talcum powder can.
- Pair of insulating boots.
- Voltage detector with autotest. Rescue hook. (127 V - 90 kV alternatif)
- Pair of insulating gloves with reinforced carrying bag.
- Safety instructions and safety first aid posters.
- Insulating platform.



Reference	Characteristics	Icc (kV)	 (mm)	 kg
			Dimension	Weight
CZ-53-R	With instructions in English	25 kV	710 x 570 x 240	21
CZ-53-MR	With instructions in English/Arabic	25 kV	710 x 570 x 240	21
CZ-53-R/2	With instructions in English	36 kV		
CZ-53-MR/2	With instructions in English/Arabic	36 kV		

BENEFITS

- Stability of the suitcase when stored vertically or horizontally.

MEDIUM VOLTAGE EQUIPMENT

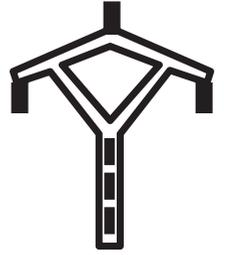

IEC VOLTAGE DETECTORS.....	184
VOLTAGE DETECTORS.....	185
SINGLE PHASE COMPARATORS.....	186
IEC EQUIPMENT	187
INSULATING STICKS.....	188
CLAMP DISPENSER AND ACCESSORIES	191
OVERHEAD LINE SYSTEMS.....	192
CABLES	193
UNDERGROUND SYSTEMS.....	195
STICKS ACCESSORIES.....	196
STORAGE AND MAINTENANCE PRODUCTS	197



IEC VOLTAGE DETECTORS

IEC ELECTRONIC VOLTAGE DETECTORS, "COMPACT SERIE" FOR INDOOR AND OUTDOOR USE

Ultimate technology of voltage detector "Head Capacitive Technology»

Compact and light, it offers a wide band (10/36 kV).

Operating check

By pressing the TEST button:

- A RED LED flashes on.
- Powerful rated audible signal > 67 dB(A)/2 m (aligned with IEC 61243-1 and to protect employee from too strong signal).
- When loosening the button, the timed GREEN LED lights up. While remaining on, it indicates the good working order of the detector.

Characteristics

- Precise and stable operating threshold.
- High environmental resistance (impacts, vibrations, moisture).
- Temperature conditions: class N (IEC 61243-1 standard).
- Use from 50 to 60 Hz.

Composition

- Robust housing.
- Weight: 350 g.
- Dimensions: Ø 59 x 270 mm.

Supplied in a rigid packaging to protect the device.



IEC 61243-1 :2003+ AC1: 2005 +A1: 2009



CC-765...C

End fitting C

CC-765...K

End fitting K



End fitting K

BENEFITS

- Results visible over 360° with a powerful light. Voltage range pre-selected to your application.

Reference		Operating voltage		
	Frequency		Type 6 LR-61	Weight
CC-765-2/72-(*)	50/60 Hz	2 - 72 kV	9 V	0.35
CC-765-3/10-(*)	50/60 Hz	3 - 10 kV	9 V	0.35
CC-765-5/18-(*)	50/60 Hz	5 - 18 kV	9 V	0.35
CC-765-5,5/20-(*)	50/60 Hz	5.5 - 20 kV	9 V	0.35
CC-765-10/30-(*)	50/60 Hz	10-30 kV	9 V	0.35
CC-765-10/36-(*)	50/60 Hz	10 - 36 kV	9 V	0.35
CC-765-11/33-(*)	50/60 Hz	11 - 33 kV	9 V	0.35
CC-765-15/45-(*)	50/60 Hz	15-45 kV	9 V	0.35
CC-765-20/66-(*)	50/60 Hz	20 - 66 kV	9 V	0.35
CC-765-30/66-(*)	50/60 Hz	30 - 66 kV	9 V	0.35
CC-765-44/132-(*) ⁽¹⁾	50/60 Hz	44 - 132 kV	9 V	0.35
CC-765-63/90-(*) ⁽¹⁾	50/60 Hz	63 - 90 kV	9 V	0.35

(*) Specify type of mounting when ordering: C or K.

(1) supplied with 1 hook-shaped contact electrode CC-ANT 120 (Ø120 mm).
Packaging: unit supplied complete in a case with batteries and contact electrodes (straight and V-shaped).
For other voltages, please consult us.

CC-775 : 2 voltage ranges detector, in compliance with IEC 61343-1

Reference	1st voltage range		2nd voltage range	
	Un min (uu)	Un Max (vv)	Un min (xx)	Un Max (yy)
CC-775-2/7-12/25-(*)	2 kV	7 kV	12 kV	25 kV
CC-775-2/72:12/36-(*)	2 kV	7.2kV	12 kV	36 kV
CC-775-2/72-34/115-(*)	2 kV	7.2 kV	34 kV	115 kV
CC-775-33/11:22/66-K	3.3 kV	11 kV	22 kV	66 kV
CC-775-4/14-24/69-K	4 kV	14 kV	24 kV	69 kV
CC-775-4/144-25/69-K	4 kV	14.4 kV	25 kV	69 kV
CC-775-47/15-25/69-K	4.7 kV	15 kV	25 kV	69 kV
CC-775-6/12-22/66-C	6 kV	12 kV	22 kV	66 kV
CC-775-11/22-33/66-K	11 kV	22 kV	33 kV	66 kV
CC-775-12/24-52/132-(*)	12 kV	24 kV	52 kV	132 kV

(*) End fitting : C or K



C

K

End fittings:

C: hexagonal 12 mm, for hexagonal end-fitting sticks,

K: universal, for universal end-fitting sticks.

Recommended stick: CE-4-21, CE-75, CE-9.



VOLTAGE DETECTORS

Checking

By pressing the test button :

- extremely bright RED flashing LED's (visible at more than 50 meters even in unfavourable light),
- powerful rated audible signal > 60 dB/2 m

The test button is released :

- a timed GREEN LED lights.

Indicating both the detector is operational and the self testing of the unit continues.

Characteristics :

- Precise and stable operating threshold.
- High environmental resistance (impacts, vibrations, moisture).

Reference		Operating voltage		
	Frequency		Type 6 LR-61	Weight
CC-365-3/10-(*)	50 Hz	3-10 kV	1.5 V	0.50
CC-365-10/30-(*)	50 Hz	10-30 kV	1.5 V	0.50

(*) Specify type of mounting when ordering: C or K.
Packaging : unit supplied complete in a case with batteries and contact electrodes (straight and V-shaped).
Total weight : 1100 g. Total size : 340 x 275 x 83 mm.
For other voltages, please consult us.

Accessories

Reference	Characteristics
CC-365-101	Flag/Vee contact electrode
C-92-492	Contact electrode for installations L = 310 mm, insulating on 300 mm



End fittings:

C : hexagonal 12 mm, for hexagonal end-fitting sticks,
K: universal, for universal end-fitting sticks.
Recommended stick:
CE-4-21, CE-75.



CC-365-K



CC-365-C



Double signaling:

Voltage presence is indicated by both:
- extremely bright RED flashing LED's (visible at more than 50 meters even in unfavourable light),
- powerful rated audible signal > 60 dB/2 m.



End fittings:

C : hexagonal 12 mm, for hexagonal end-fitting sticks, K: universal, for universal end-fitting sticks.
Recommended stick:
CE-4-21, CE-75.

C 18-311

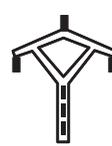



IEC/EN 61481



SINGLE POLE PHASE COMPARATOR FOR INDOOR AND OUTDOOR USE

Unipolar device used to check phase concordance in 2 steps.

- Step 1: storage of the reference phase.
- Step 2: search for the phase in concordance with the one memorised in step 1.

The operator has 15 seconds to complete step 2.

After this time, step 1 must be started again.

To be used on 50 and 60 Hz networks.

Reference				
	Frequency	Type 6 LR-61	Length	Weight
CL-7-06/18-(*)	6-18 kV	9 V	0.55 m	0.85
CL-7-10/30-(*)	10-30 kV	9 V	0.90 m	0.90
CL-7-10/30-1-(*)	10-30 kV	9 V	1.15 m	0.95
CL-7-12/36-(*)	12-36 kV	9 V	0.90 m	0.90

(* Please specify type C or K when ordering. Delivered in carrying case.



Fixation C or K.

GREEN LED = phasing indication.

ORANGE LED = memorized phase status voltage are in memory.

RED LED = non-phasing indication.



Press the button to test the device and to reset its memory.



IEC SHORT-CIRCUITING AND EARTHING SYSTEMS (THREE-PHASE CROSSARM NETWORKS)

MT-613 are an automatic contact clamps. They must be fitted from above the conductor using a MT-635/1-C dispenser.

IEC 61230 : 2008

Reference	Equipment composition
MT-6613	3 automatic contact clamps MT-613 Connection cables 35 mm ² , max. gap between clamps: 2.75 m 1 clamp dispenser head MT-635/1-C 1 spool with earthing cable connection MT-640-S 1 carrying bag M-87295
MT-6613/1	3 automatic contact clamps MT-613 Connection cables 95 mm ² , max. gap between clamps: 3 m 1 clamp dispenser head MT-635/1-C 1 earthing cable connection 15 m x 35 mm ² 1 earthing clamp MT-840/1 1 carrying bag M-87295

Reference	Rating (kA/1 s)	Connection copper cable between clamps (mm ²)	Earth connection copper cable (mm ²)	Ø (mm)
				Conductor
MT-6613 *	8	35	16	5 to 30
MT-6613/1 **	17.5	95	35	5 to 30

* Recommended sticks: CE-4-21-C.
** Recommended sticks: CM-4, CF-5, CM-7 et CM-4000.

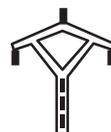
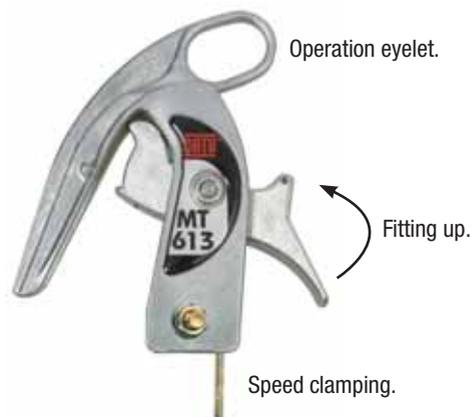

BENEFITS

- Rapidity and ease of handling.
- Quick removal: Simply grab the clamp with the «pigtail» of the dispensing head and pull it out.

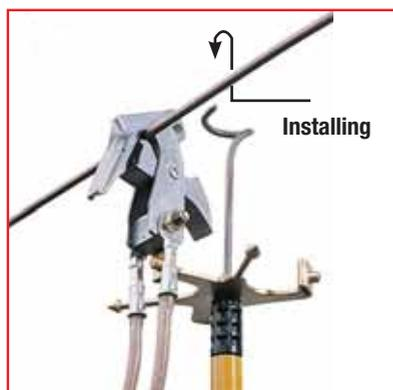
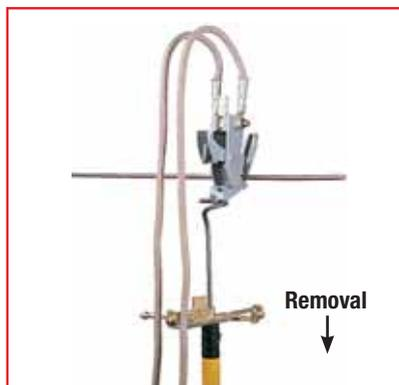



INSULATING STICKS

INSULATING STICKS FOR SUBSTATION

Short circuiting and earthing systems for substation. Telescopic sticks for voltage detectors and earthing systems for use in dry and wet conditions.

PRO

An upper orange element made of glass fiber/resin epoxy foam filled of 32 mm diameter (**).

Reference	Icc max (kV)	Ø (mm)	Length (m)		Weight (kg)
			Folded	Unfolded length	
CE-75-(**)	75	41/32	1.15	2	1.3
CE-4-21-(*)	90	41/32	1.15	2	1.5
CE-4-30-(*)	150	41/32	1.75	3	2
CM-7-10-A	Extension	36	-	1	1

(*) Specify type of mounting when ordering : C, K or E.
(**) Specify type of mounting when ordering : C or K.

Reference	Icc max (kV)	Ø (mm)	Length (m)		Weight (kg)
			Folded	Unfolded length	
CE-5-105-X	220	63.5/27.5	1.66 m	10.75 m	5.4
CE-5-90-X	220	57.5/27.5	1.61 m	9.25 m	4.2
CE-5-70-X	220	52.5/27.5	1.56 m	7.8 m	3.3
CE-5-60-X	220	47.5/27.5	1.51 m	6.4 m	2.5
CE-5-50-X	220	42.5/27.5	1.46 m	5 m	1.9

X : Specify type of mounting when ordering.
(K : universal ; C : hexagonal, 12 mm on flat surfaces).

BENEFITS

- CE-4-21-(*) and CE-4-30-C: Certified telescopic rod IEC 62193 (2003) and IEC 61235. Hand shield. CE-75-(*) : Certified telescopic rod IEC 62193 (2003) and tube IEC 60855-1. CE-75-C: Enedis authorisation: 18-130 B
- CE-5-(**): Certified telescopic rod IEC 61235.
- CE-75 and CE-4 series: 1. Ensure user about the right way to set and use the stick. 2. Avoid any twist when deploying or folding the stick.

FIXED LENGTH STICKS

Suitable for wet conditions.

Reference	Icc max (kV)	Ø (mm)	Length (m)		Weight (kg)
			Length (m)	Skirt nbr	
CF-5-90-(*)	90	36	2	1	1.55
CF-5-110-(*)	110	36	2.50	2	2
CF-5-170-(*)	170	36	3	3	2.4

(*) Please specify type C, K or E when ordering.

BENEFITS

- CF-5 : Insulating skirts (Ø 100 mm, H90 mm) for use in rain.





WALL MOUNTED SUPPORTS

For sticks and voltage detectors. Plastic.

Reference	Recommended sticks	Ø (mm)	
		Top	Bottom
CI-08	CE-2	16-20	36 max
CI-06-D	CS-45, CS-90, CS-225	28-30	36 max
CI-12-D	MT-830P	28-30	58 max
CI-10-D	CE-421, CE-430, CF-372, ZPLET	32-36	58 max
CI-15-D	CM 4600 serie	39	58 max
CI-18-D	CM-6, CE-5	42-48	58 max



INTERMEDIATE ELEMENTS WITH RAIN SKIRTS

Intermediary element with skirt, which can be located on all the references mentioned above.

Reference	↔ (m)	kg
	Length smallest end fitting	Weight
CM-4400-J	0.362	0.95



INSULATING STICK COVERS

For storage and transport. Waterproof canvas and zipper closure. Adjustable straps. Transparent pocket for identification.

CM-1-....: for 1 to 3 poles.

CM-3-....: for CM-6 series or 5 simple elements or 4 double elements.

Reference	(mm)
	Dimension
CM-1-10	1.30 m length
CM-1-15	1.80 m length
CM-1-20	2.40 m length
CM-3-03	0.575 x 1.950 m (elmt 1.75 m length)
CM-3-04	0.575 x 2.450 m (elmt 2 m length)
CM-3-05	0.575 x 2.850 m (elmt 2.50 m length)
CM-3-06	0.575 x 3.400 m (elmt 3 m length)





CONNECTION ADAPTORS FOR INSULATING STICKS

C	K	E	S	A ou B	*	H
Hexagonal femal 6 sides	Universal	Bayonet	Clamp stick	For stick CM-4 / CM-6 / CM-7.	-	-

Accessories					
	C	K	E	*	H

Connection adaptors															
	CI-7-C	CI-3-C	CI-6-C2	CI-5-C	CI-3-K	CI-4-K	CI-6-K	CI-7-K	CI-5-K	CI-3-E	CI-7-E	CI-4-E	CI-D-K	CI-6-H	CI-3-H

Sticks															
	E	AB	K	S	AB	C	K	E	S	AB	K	C	K	K	AB

With this range any accessory can be attached to any stick by using connection adaptors. Other models, please consult us.

CLAMP DISPENSER HEADS

Copper aluminium alloy.

For MT-613/1 and 613/2 clamps

Reference	Head for 3 clamps	Head for 4 clamps	With pigtail hook
MT-630-C	■		
MT-630-K	■		
MT-630-S	■		
MT-635/1-C/K/S	■		■
MT-634-C/K		■	
MT-633-C	■		■
MT-633-K	■		■
MT-633-S	■		■
MT-634/1-C/K		■	■

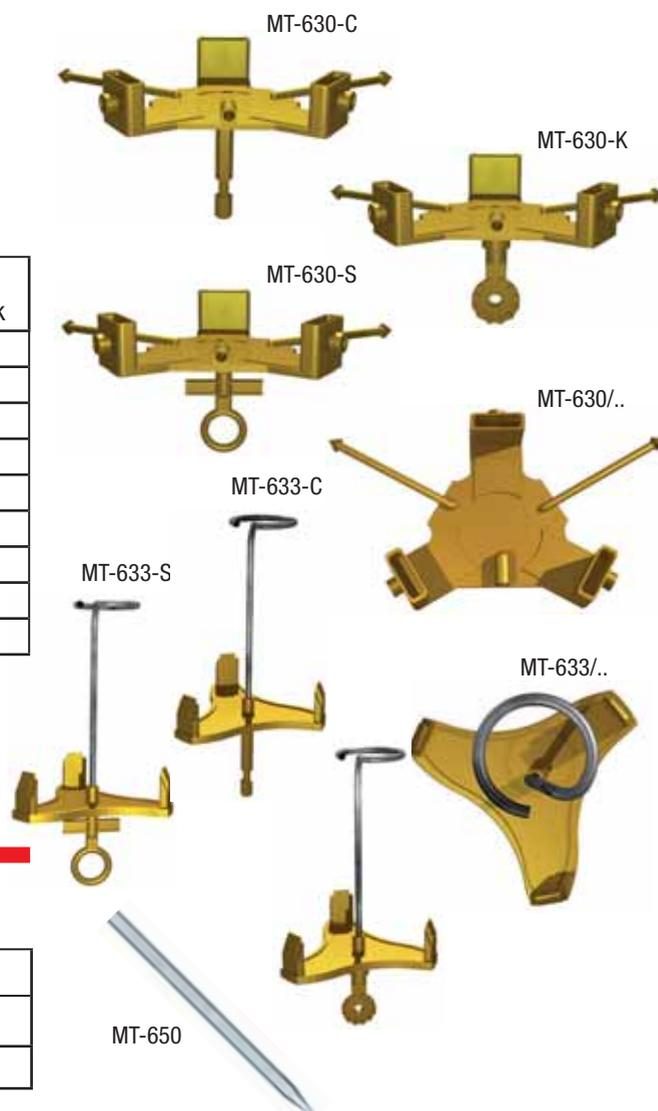

EARTH ROD

Reference	Characteristics	↔ (m)
		Length
MT-650	Hexagonal section rod	1

EARTH CLAMPS

Copper aluminium bronze earth clamps.

Reference	Rating (kA/1 s)	Conductors (mm)		Weight
		∅	—	
MT-840/1	20	6-25	0-25	480
MT-843	40	6-35	0-35	950

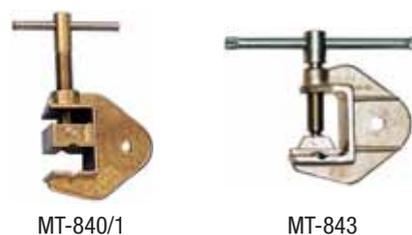

SPOOL WITH EARTHING CONNECTION

Spool with cable and earth clamp.

Reference	Silicone cable (mm²)	↔ (m)
		Length
MT-640-S	16	16
MT-641-S	16	25



IEC 61230 : 2008

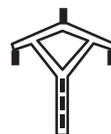



SHORT-CIRCUITING AND EARTHING SYSTEMS

Installed from the ground on conductors up to 10.50 m.

Easier installation features.

Re-inforced insulating stick (36 mm dia.).

Self locking contact clamp: powerful conductor clamping with high end performance at short-circuiting, does not slide.

More rigid metallic stick. Lower tube 30.6 mm dia.

Upper tube 16 mm dia.

Re-inforced insulating stick (36 mm dia.).

On all models: Reinforced insulating pole: Epoxy/fibreglass resin over Ø 36 mm PV foam with a non-skid area.

This equipment can be used for rigid deployed poles for easy installation.

IEC 61230 : 2008 

Reference	Rating (kA/1 s)	Ø (mm)
		Conductors
MT-508/36	8	3-22
MT-508/46	8	3-22

Reference	Equipment composition
MT-508/36	3 telescopic metallic sticks 3 elements L = 6.00/2.37 m - 2.4 kg - MT-512/36 1 insulating stick 2 elements 1.65 m - MT-531 Reel for 3 cables 10 m x 35 mm ² with earth connect. for attachment to stick - MT-543/35 1 earth rod 1 m - MT-650 1 bag 2.50 x 0.30 x 0.15 - M-87-127
MT-508/46	3 telescopic metallic sticks 4 elements L = 5.10/1.62 m - 2.1 kg - MT-512/46 1 insulating stick 2 elements 1.65 m - MT-531 1 insulating intermediate stick element 1.65 m - CM-4-165-B 1 stick lifter - MT-546 Reel for 3 cables 10 m x 35 mm ² with earth connect. for attachment to stick - MT-543/35 1 earth rod 1 m - MT-650 1 bag M-87-208

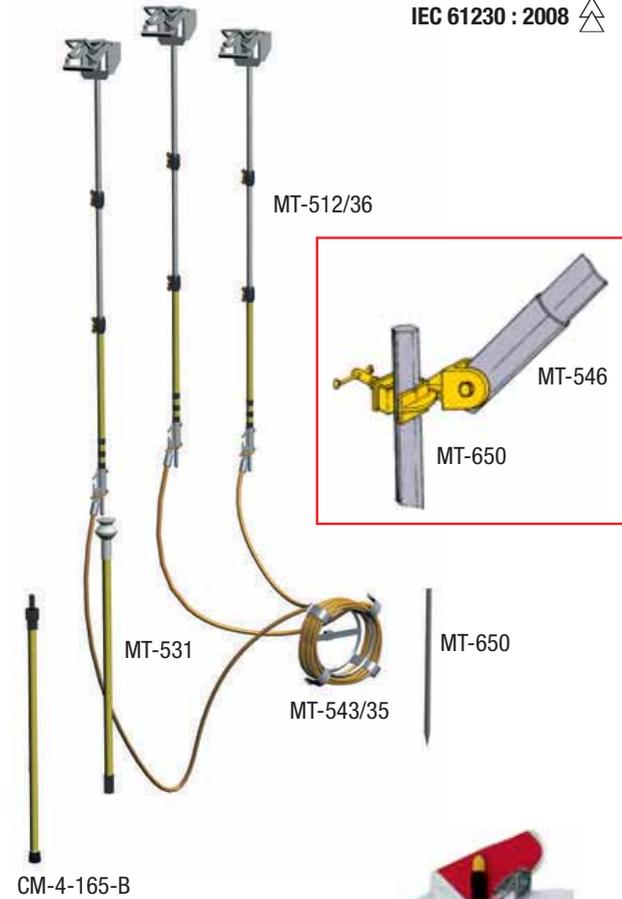

Self-locking clamp
No spring for easier maintenance, removal, and greater reliability.



BENEFITS

- Installation from the ground.
- Self-locking contact clamp.



COPPER CABLES

Extra flexible braided multi-strand copper cables. Delivered to the meter with a minimum of 5 meters. Available in PVC sheath (A) or silicone sheath (B).



IEC 61230 : 2008

PVC sheath

Reference	Section (mm ²)	kA/1s	kA/0.8s	kA/0.5s	kA/0.4s	kA/0.3s	kA/0.2s	kA/0.1s	kA/0.07s	kA/0.04s	Insulated cable	
											Weight (g/m)	Ø (mm)
M-24-16	16	4.5	5	6.3	7	8.2	10	14.2	17	22.5	180	8.6
M-24-25	25	7	7.8	10	11	12.7	15.6	22	26.5	35	280	10.2
M-24-35	35	10	11.2	14	15.8	18.2	22.3	31.6	37.8	50	380	11.7
M-24-50	50	14	15.6	20	22	25.5	31.3	44.3	53	70	530	14.2
M-24-70	70	20	22.3	28.3	31.6	36.5	44.7	63.2	75.5	100	780	16.2
M-24-95	95	27	30.2	38.2	42.7	49.3	60.4	85.4	102	135	1000	18.7
M-24-120	120	34	38	48	53.7	62	76	107.5	128.5	170	1300	20.6
M-24-150	150	42.5	47.5	60	67.2	77.6	95	134.4	160.6	212.5	1540	22.5

Theoretical calculations.

BENEFITS

- PVC sheath extra flexible.
- Reinforced short circuit resistance.

Silicone sheath

Reference	Section (mm ²)	Rating (kA/1 s)	Without sheath cable	
			Weight (g/m)	(mm)
M-24-16-S	16	4	156	5.6
M-24-25-S	25	6	275	7.5
M-24-35-S	35	8	386	9
M-24-40-S	40	10	440	9.5
M-24-50-S	50	12	545	10
M-24-70-S	70	16	768	12
M-24-95-S	95	20	1000	14
M-24-120-S	120	30	1280	17
M-24-150-S	150	40	1630	19

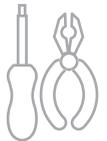



ALUMINIUM CABLES

Extra flexible braided multi-strand cables. Transparent PVC sheath, with cable section identification.

Reference	Rating (kA/1 s)	Without sheath cable		Section (mm ²)
				
		Weight (g/m)	(mm)	
M-28-50	7	170	11.5	50
M-28-70	10	240	13.4	70
M-28-120	17.5	430	19	120
M-28-150	20	510	21	150



IEC 61230 : 2008 



JUMPER CABLES SPECIALLY MANUFACTURED ITEMS

Three copper cables or braids for short circuiting, connected to a copper ground wire through a trifurcating box. Transparent PVC sheath.

Reference	Characteristics	Rating (kA/1 s)	
			Weight
MT-40	3 cables 40 mm ² - L = 0.75 m 1 earth cable 40 mm ² - L = 2 m	10	2.3
MT-70/1	3 cables 70 mm ² with equipped lugs - L = 1.20 m 1 earth cable 35 mm ² - L = 2 m	14.5	4.4



ON REQUEST CONTACT OUR TECHNICAL ASSISTANCE

We realize specific earthing and short circuiting systems with crimped cables.

**Phone : (33) 01 42 31 63 10 and (33) 01 42 31 46 24
www.catuelec.com**





CABLE TESTING STICK

Enables piercing of cable insulation and shielding, earthing up to 50 kV. Capacity: 70 mm dia.
 Cable-guide with protecting guide. 0.60 m insulating sleeve with 0.80 m extender.
 Double cutting angle blade.
 Multistrand copper earth wire 70 mm² x 2.50 m with earth clamp.
 Ratchet type operating handle.

Reference	↔ (m)	∅ (mm)	kg (mm)
	Length		
MP-211	1.60	60 maxi	8.75
Carrying Case available separately (MP-02).			



IEC 61230 : 2008



INSULATING BLANKET

Must be placed over the piercing point. Hole for handle.

Reference	□ (mm)	∅ (mm)	kg Weight
	Dimension		
MP-212	900 x 900	50	0.96



IEC 61230 : 2008



CABLE SPIKE EQUIPMENT

Device to test the voltage on underground cables (1st and 2nd categories) and their earthing, using a system with 9** mm bullet and throwing in the cable a steel treated blade.

Reference	Characteristics	kg
		Weight
MP-213 *	Cable spike	20
MP-213/LAM	Spare blade for spade-cable MP-213	0.02
MP-213/EXT	Blade extractor for spade-cable MP-213	0.20

* Delivered complete in suitcase.
 ** 9 mm bullet not included and not supplied by CATU.

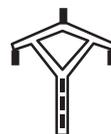



STICKS ACCESSORIES

MANOEUVERING HOOK

Reference	Characteristics	
		Weight
CM-02-(*)	Bronze-copper nickel aluminium	0.12
CM-03-K	Bronze-copper nickel aluminium	0.12

(*) Add end-fitting: C, E or K.



CM-02-K



CM-02-C



CM-03-K

CLEANING BRUSHES

Reference	Characteristics	 (mm)	
		Dimension	Weight
MD-10-C	Concave brush with two rows of perpendicular bristle	100 x 125 x 170	0.5
MD-12-C	Round head brush	175 x 228	0.5
MD-14-C	Adjustable hinged round head brush	175 x 328	0.5



MD-12-C



MD-10-C



MD-14-C

TRIMMER AND PRUNNING SAW

Reference	Characteristics	 (mm)	
		Dimension	Weight
MD-40-B	Trimmer, maximum capacity Ø 45 mm (for branches up to 28 mm depending on tree species)	375 x 240 x 60	1.2
MD-42-B	Pruning saw on rigid frame, 34 cm blade	125 x 610 x 60	1.1
M-92-28	Replacement blade MD-42-B	—	—



MD-40-B



MD-42-B

FUSE PULLER

Reference	 (mm)	Ø (mm)
	Dimension	
CM-04-K	230 x 80	up to 70



ROD TESTER

The portable rod tester is designed to measure leakage currents originating from the absorption of humidity or pollution on the surface of insulating rods conform to IEC 60855 standard.

The rod tester does not require any particular gauging and works according to the "Good / No good" principle and there is no need for any particular interpretation of the results. The validation of the satisfactory state of the rod takes place by means of a clear information on the galvanometer screen.

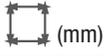
Reference	Characteristics	 (mm)	 kg
		Dimension	Weight
MX-215	Rod tester	210 x 480 x 350	10.2

BENEFITS

- In accordance with ERDF BT MT 82 specification.
- Quick and simple use.



Easily transportable.



RAILWAYS

ELECTRICAL SAFETY EQUIPMENT



CATU™

HV LINES AND SWITCHGEAR EQUIPMENT

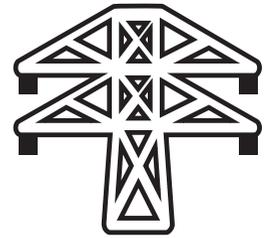

VOLTAGE DETECTORS.....	200
INSULATING STICKS.....	202
CLAMPS	203
EARTHING SYSTEM (APE)	204
EARTH CLAMPS AND CABLES.....	205
CABLES AND ACCESSORIES	206
ACCESSORIES.....	207



VOLTAGE DETECTORS

IEC ELECTRONIC VOLTAGE DETECTORS (MV), "COMPACT SERIE" FOR INDOOR AND OUTDOOR USE

Ultimate technology of voltage detector "Head Capacitive Technology»

Compact and light, it offers a wide band (10/36 kV).

Operating check

By pressing the TEST button:

- A RED LED flashes on.
- Powerful rated audible signal > 67 dB(A)/2 m.
- When loosening the button, the timed GREEN LED lights up. While remaining on, it indicates the good working order of the detector.

Characteristics

- Precise and stable operating threshold.
- High environmental resistance (impacts, vibrations, moisture).
- Temperature conditions: class N (IEC 61243-1 standard).
- Use from 50 to 60 Hz.

Composition

- Robust housing.
- Weight: 350 g.
- Dimensions: Ø 59 x 270 mm.



IEC 61243-1 :2003+ AC1: 2005 +A1: 2009



CC-765...C

End fitting C

CC-765...K

End fitting K

BENEFITS

- Results visible over 360° with a powerful light. Voltage range pre-selected to your application.

Reference		Operating voltage		
	Frequency		Type 6 LR-61	Weight
CC-765-2/72-(*)	50/60 Hz	2 - 72 kV	9 V	0.35
CC-765-3/10-(*)	50/60 Hz	3 - 10 kV	9 V	0.35
CC-765-5/18-(*)	50/60 Hz	5 - 18 kV	9 V	0.35
CC-765-5,5/20-(*)	50/60 Hz	5.5 - 20 kV	9 V	0.35
CC-765-10/30-(*)	50/60 Hz	10-30 kV	9 V	0.35
CC-765-10/36-(*)	50/60 Hz	10 - 36 kV	9 V	0.35
CC-765-11/33-(*)	50/60 Hz	11 - 33 kV	9 V	0.35
CC-765-15/45-(*)	50/60 Hz	15-45 kV	9 V	0.35
CC-765-20/66-(*)	50/60 Hz	20 - 66 kV	9 V	0.35
CC-765-30/66-(*)	50/60 Hz	30 - 66 kV	9 V	0.35
CC-765-44/132-(*) ⁽¹⁾	50/60 Hz	44 - 132 kV	9 V	0.35
CC-765-63/90-(*) ⁽¹⁾	50/60 Hz	63 - 90 kV	9 V	0.35

(*) Specify type of mounting when ordering: C or K.

(1) supplied with 1 hook-shaped contact electrode CC-ANT 120 (Ø120 mm).

Packaging: unit supplied complete in a case with batteries and contact electrodes (straight and V-shaped).

For other voltages, please consult us.

CC-775 : 2 voltage ranges detector, in compliance with IEC 61343-1

Reference	1st voltage range		2nd voltage range	
	Un min (uu)	Un Max (vv)	Un min (xx)	Un Max (yy)
CC-775-2/7-12/25-(*)	2 kV	7 kV	12 kV	25 kV
CC-775-2/72-12/36-(*)	2 kV	7.2kV	12 kV	36 kV
CC-775-2/72-34/115-(*)	2 kV	7.2 kV	34 kV	115 kV
CC-775-33/11-22/66-K	3.3 kV	11 kV	22 kV	66 kV
CC-775-4/14-24/69-K	4 kV	14 kV	24 kV	69 kV
CC-775-4/144-25/69-K	4 kV	14.4 kV	25 kV	69 kV
CC-775-47/15-25/69-K	4.7 kV	15 kV	25 kV	69 kV
CC-775-6/12-22/66-C	6 kV	12 kV	22 kV	66 kV
CC-775-11/22-33/66-K	11 kV	22 kV	33 kV	66 kV
CC-775-12/24-52/132-(*)	12 kV	24 kV	52 kV	132 kV

(*) End fitting : C or K



C

K

End fittings:

C: hexagonal 12 mm, for hexagonal end-fitting sticks,

K: universal, for universal end-fitting sticks.

Recommended stick: CE-4-21, CE-75, CE-9.

IEC VOLTAGE DETECTORS (HV) FOR OUTDOOR USE

Precise and stable operating threshold. Insensitivity to induced voltages by limiting the operating voltage range. Remarkably resistant to impacts, vibrations, extreme temperatures, humidity.

Double signalling.

Voltage presence indicated at the same time by:

- 4 bright **RED** flashing electro-luminescent diodes (visible at more than 50 meters even in direct lighting),
- a powerful rated acoustic signal (60 dB/2 m).

The CC-265 detector is supplied with 3 end fittings for stick mounting:

W: Hexagonal 20 mm,

C: Hexagonal 12 mm,

K: Universal.

Robust housing made from polycarbonate with high mechanical properties and dielectric strength.

Check that the device is working by pressing the TEST button. This test all of the detector's active components once the TEST button is released.

Two **GREEN** illuminated lights, indicating that the device is on. These lights turn off, and four **RED** lights illuminate when a voltage is detected.

Power supply : 1 battery 9 V type 6LR61 (included).

Storage temperature : - 25 /+ 55°C.



IEC 61243-1 :2003+ AC1: 2005 +A1: 2009



BENEFITS

- Illuminated display Broadcast over 360°.
- Use in rain conditions.
- Shock Absorber fitting.
- New fixation ring (for the hook).

NEW

- 360° vision for optimal visibility.
- Delivered with 3 end fittings.

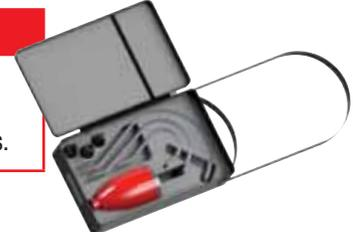

Reference		Housing Colour	IEC 61243-1	Contact electrode	Contact electrode (Ø mm)	
	Voltage range					Detector weight
CC-265-44/132 (*)	44 - 132 kV	■	•	CC-ANT120	120	0.68
CC-265-60/90 (*)	60 - 90 kV	■	•	CC-ANT60 & CC-ANT120	60 - 120	0.68
CC-265-60/150 (*)	60 - 150 kV	■	•	CC-ANT60 & CC-ANT120	60 - 120	0.68
CC-260-60/235 (*)	60 - 235 kV	■	-	CC-ANT120	120	0.68
CC-265-90/225 (*)	90 - 225 kV	■	•	CC-ANT120	120	0.68
CC-265-120/245 (*)	120 - 245 kV	■	•	CC-ANT200	200	0.68
CC -260-132/380 (*)	132 - 380 kV	■	-	CC-ANT200	200	0.68
CC-260-150/420 (*)	150 - 420 kV	■	-	CC-ANT200	200	0.68
CC-265-225/420 (*)	225 - 420 kV	■	•	CC-ANT60, CC-ANT120, CC-ANT200	60, 120, 200	0.68
CC-260-225/550 (*)	225 - 550 kV	■	-	CC-ANT200	200	0.68

Delivered with modern, lightweight and impact-resistant case.

(*) Please specify type of mounting when ordering: C or K

For other voltage ranges, please consult us.



INSULATING STICKS

INSULATING STICKS FOR MANOEUVERING DETECTORS & SHORT-CIRCUITING AND EARTHING SYSTEMS

This range thus allows a stick-length limitation in case of space requirements and carrying capabilities. For common applications a serie of complete sets including 2 or 3 elements are providing simple solutions for working distance from 2 to 6 meters.

	Reference	↔	↔	↔	kg
		Smallest end fitting (m)	Longest end fitting (m)	Insulating (m)	Weight
Basic	CM-4610	1.13	–	–	1.25
	CM-4615	1.63	–	–	1.70
	CM-4620	2.13	–	–	2.70
	CM-4625	2.63	–	–	3.20
Intermediate	CM-4610-I	1.165	–	–	1.20
	CM-4615-I	1.665	–	–	1.60
	CM-4620-I	2.165	–	–	2.50
	CM-4625-I	2.665	–	–	3.00
Terminal	CM-4610-(*)	1.115	1.21	1.21	0.90
	CM-4615-(*)	1.615	1.71	1.71	1.30
	CM-4620-(*)	2.115	2.21	2.21	2.10
	CM-4625-(*)	2.615	2.71	2.71	2.60
Fixed sticks	CM-4115-(*)	1.575m	1.675	1.675	1.35
	CM-4120-(*)	2.075	2.175	2.175	1.8
	CM-4125-(*)	2.575	2.675	2.675	2.8
	CM-4130-(*)	3.075	3.175	3.175	3.3

(*) Reference to be completed by fitting: C-E-H-K-T-D.



IEC 60855 
EN 50508

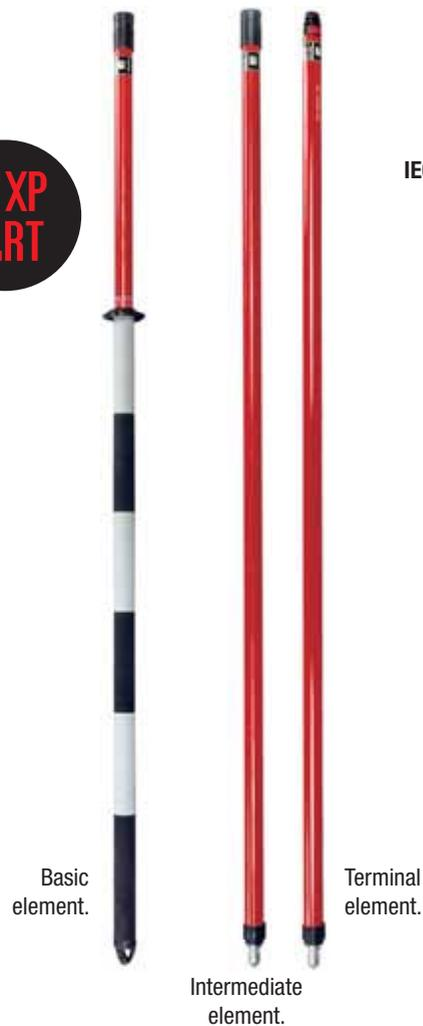

Basic element.

Terminal element.

Intermediate element.

Insulating Stick bags page 189



SET OF STICKS

Complete sets of sticks for common applications.

Reference	Composition**	↔	Icc (kV)
		Lenght (m)	
CM-4220-(*)	2 elements : CM-4610+CM-4610-(*)	2	90
CM-4230-(*)	2 elements : CM-4615+CM-4615-(*)	3	170
CM-4240-(*)	2 elements : CM-4620+CM-4620-(*)	4	220
CM-4345-(*)	3 elements : CM-4615+CM-4615-I+CM-4615-(*)	4.5	310
CM-4360-(*)	3 elements : CM-4620+CM-4620-I+CM-4620-(*)	6	410

(*) Reference to be completed by fitting: C, E, H, K, T et D.

(**) References sold separately on request.

Intermediate element with rain skirts.

Reference	↔	kg
	Smallest end fitting (m)	Weight
CM-3900-J	0.36	0.95



CM-3900-J



CLAMPS

Body in aluminium alloy with trapezoidal threaded screw. Interposed elastic washers in the clamping system improve efficiency and ensure a higher withstand in case of electrodynamic shock. Manoeuvring by CM-6 insulated stick of appropriate length and characteristics.

PRO

IEC 61230 : 2008 



MT-731-E

MT-732-E

MT-734

MT-735-H

MT-737-H

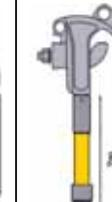
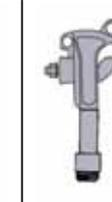
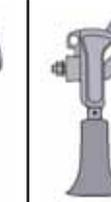
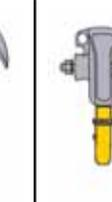
Manoeuvrable clamps									
	MT-732-A MT-731-A	MT-732-B MT-731-B	MT-732-E MT-731-E	MT-732-H MT-731-H	MT-734 MT-735	MT-734-A MT-735-A	MT-734-B MT-735-B	MT-734-E MT-735-E	MT-734-H MT-735-H

Reference	Icc (kA/1 s)	Dimension (mm)	Copper connection			Clamp capacity (mm)	Weight (kg)
			Copper cables **	Contact range width	Stud		
MT-731-(*)	40	200 x 200 x 50	150 mm ² max.	45 mm	M 12	Ø 5-60	1.45
MT-732-(*)	40	200 x 200 x 50	150 mm ² max.	45 mm	M 12	Ø 40-120	1.45
MT-734-(**)	40	145 x 125 x 52	150 mm ² max.	40 mm	M 12	Ø 5-40	0.8
MT-735-(*)	40	178 x 175 x 60	150 mm ² max.	40 mm	M 12	Ø 15-60	0.9
MT-737-H	40	240 x 200 x 55	150 mm ² max.	40 mm	M 12	Ø 20-120	1.35

(*) Add type of connection A - B - E - H. (**) Add type of connection B - E - H. **Other cable sections: see page 205 - 206.

Attachment of MT-735 or MT-734 clamps with MT-717-3-B hook.

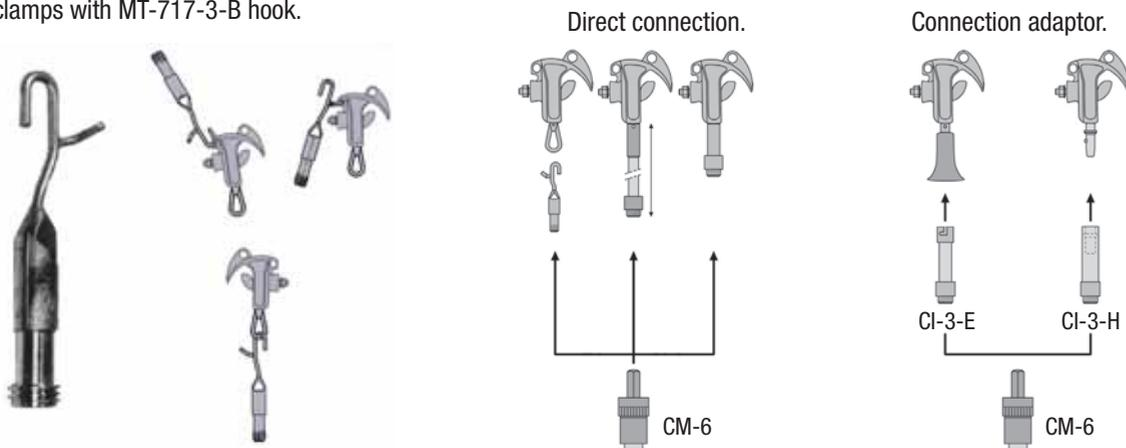



EARTHING SYSTEM WITH INTERLOCKING CLAMPS

IEC 61230 : 2008 

The APE is a grounding system with an interlocking system between earthing and line clamps. It is used for safe and accurate installation (earthing clamp and then line clamp) and removal (line clamp and then earth clamp).

BENEFITS

- Locking system using a patented system with more than 30,000 possible combinations.
- Easy installation and removal without additional accessories.
- Automatic trip at the recommended torque on support withstand the short circuit current.
- System security (unable to be unlocked without the associated clamp).



Substation clamp

Line clamp



One reference including 3 phases, so 3 clamps equipped.

Reference	Rating kA/1 s	Use	Fitting	Connection		□ (mm) Dimension	∅ (mm)	 Weight
				Range	Stud			
MT-834-H	40	Substation	H hexagonal	width 38 mm	M 12	360 x 200 x 85	5 - 40	3.2
MT-834-E	40	Substation	E bayonet	width 38 mm	M 12	360 x 200 x 85	5 - 40	3.2
MT-834-T	40	Substation	T bayonet	width 38 mm	M 12	360 x 200 x 85	5 - 40	3.2
MT-835-H	40	Substation	H hexagonal	width 38 mm	M 12	390 x 200 x 85	15 - 60	3.48
MT-835-E	40	Substation	E bayonet	width 38 mm	M 12	390 x 200 x 85	15 - 60	3.48
MT-835-T	40	Substation	T bayonet	width 38 mm	M 12	390 x 200 x 85	15 - 60	3.48
MT-837-H	40	Substation	H hexagonal	width 38 mm	M 12	470 x 220 x 85	20 - 120	3.88
MT-837-E	40	Substation	E bayonet	width 38 mm	M 12	470 x 220 x 85	20 - 120	3.88
MT-837-T	40	Substation	T bayonet	width 38 mm	M 12	470 x 220 x 85	20 - 120	3.88
MT-934	40	Line	ring	width 38 mm	M 12	360 x 200 x 85	5 - 40	3.2
MT-935	40	Line	ring	width 38 mm	M 12	390 x 200 x 85	15 - 60	3.48

EARTH CLAMPS FOR OVERHEAD LIVE NETWORKS AND SUBSTATIONS

IEC 61230 : 2008 

Copper aluminium bronze earth clamps.



MT-843



MT-843-P



MT-847



MT-852

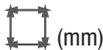
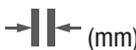

MT-853

Reference	Rating kA/x s	Use	Connection Ø (mm)	 (mm)	 (mm)	 kg
				Dimension	Clamp capacity	Weight
MT-843	40 kA/1 s	Substation/ Overhead line	Hole : Ø 12.5	45 x 106 x 165	• Ø 6 -25 - 0 - 35	0.95
MT-843-P	40 kA/1 s	Substation	3 Holes : Ø 12.5	45 x 106 x 165	• Ø 6 -35 - 0 - 35	0.95
MT-847	25 kA/0.5 s	Overhead line	Hole : Ø 13	45 x 106 x 170	- 0 - 30	1.00
MT-852	63 kA/0.5 s	Substation	Hole : Ø 13	70 x 125 x 155	Fixed points	1.40
MT-853	40 kA/0.5 s	Substation	Hole : Ø 13	65 x 130 x 135	Fixed points	1.00

COPPER CABLES

Extra-flexible braided multi-strand copper.
Delivered to the meter with a minimum of 5 meters.
Available in vinyl or silicone sheath.

IEC 61230 : 2008 

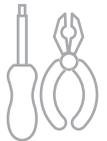



EQUIPOTENTIAL LINES

Use

Conductive line connecting two pieces of metallic pieces in order to give them the same potential.

- Cable composition and features:

35 mm² copper cable insulated in a green silicone sheathing.
Double crimped lugs at the cable ends.

Reference	Characteristics
M-24-35-V	Cable 35 mm

- Clamp and stick composition and features:

Insulating stick equipped with a clamp MT-735 in aluminium alloy with Ø 15 to 60 mm clamp capacity.

Reference	Characteristics
MT-735-P4	Clamps MT-735 on stick 400 mm

- Earth Clamp composition and features:

All the earth clamps of page 205 are available to complete the equipotential lines.



IEC 61230 : 2008



ALUMINIUM CABLES

Extra flexible braided multi-strand cables. Transparent PVC sheath, with cable section identification.

Reference	Rating (kA/1 s)	Cable		Section (mm ²)
		Weight (kg/m)	Ø (mm)	
M-28-70	10.0	0.240	13.4	70
M-28-120	17.5	0.430	19.00	120
M-28-150	20.0	0.510	21.00	150

IEC 61230 : 2008

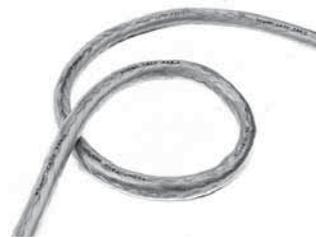

ADJUSTABLE ACCESS POINTS

For large vertical or oblique heavy duty conductors.



Reference	Characteristics	Use	(mm)	Conductor		
			Dimension	Type	Ø (mm)	Weight
MT-790	Copper/Alu alloy Ø 18 mm	30	255 x 105 x 50	Copper	12 - 60	1.40
MT-792	Light alloy Ø 20 mm	30	270 x 105 x 60	Aluminium	12 - 60	0.85
MT-797	Light alloy Ø 20 mm	30	240 x 170 x 60	Aluminium	60 - 120	1.20

SHORT-CIRCUITING AND EARTHING SYSTEM CARRYING BAGS

Can receive earthing system equipment (clamps and cables). Double crimped lugs at the cable ends.

Reference	(mm)	kg
	Dimension	Weight
M-87-53	380 x 250 x 400	2
M-87-153	380 x 250 x 600	2.5
M-87295	550 x 300 x 300	1.5



M-87295



M-87-153



ROPE OPERATED CLAMP

Attachment and removal is carried out from the ground or from the cross-arm, using a rope passed previously over the conductor to be earthed. Up to 10 m: by using **MT-709-B** reel launcher placed on a stick that passes the rope over the conductor;

- This projector fires an arrow carrying a braided nylon wire which sets the rope. The clamp is then fixed to the rope and attached onto the conductor.

Attachment: the clamp is pulled up by the rope. Pulling on the rope triggers the spring and closes the jaw.

Removal: pulling on the rope attached to the hinged saddles causes the clamp to pivot and free the jaw.

Spring operated swinging jaw with pre-set.

IEC 61230 : 2008



Reference	(mm)	Icc (kA/1 s)	(mm)	kg
	Clamp capacity		Dimension	Weight
MT-701/1	Ø 12 - 48	30	195 x 120 x 175	2
	Earthing cable: cable 120 mm ² with crimped lugs on M12 screw (x3)			



MT-709-B



MT-708-40



MT-701/1





WIRE GUN TESTER

An extremely simple way to test the voltage in an overhead line without leaving the ground. Just shoot a weighted arrow over the line - up to 18 m high - forming contact between the conductors through a very lightweight braided steel cable.

If they are both live, this produces a sparkover and alerts the user. The **MF-60** gun can also be used to shoot an insulating cord for handling **MT-701/1** contact clamps.

Reference	Characteristics
MF-60	Complete cable-launcher projector delivered in a waterproof bag with 2 spare arrow and 2 spool of 30 m fuse wire, 3.5 kg
MF-61	Spare arrow
MF-62	Spool of 30 m of fuse wire
MF-63	Spool of 100 m of fuse wire
MF-66	Spool of 30 m of nylon lead isolated hoisting cord.isolantes



MV LIVE WORKING SAFETY SHOES AGAINST ELECTRICAL HAZARDS OF STEP VOLTAGE



- Medium network voltage: Electrical Hazard Resistance 18 kV.
- Ideal for work at height (ladder, pylon).

BENEFITS :

Light and comfortable

Standards

EN ISO 20345 :2011

ASTM F 2413:2018

RTE SERECT : ST HTA 70A Ind. E

Wear indicator



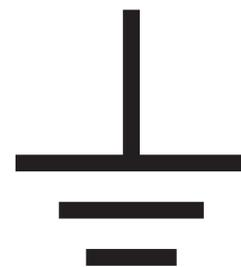

EARTHING CONNECTIONS



EARTH RODS.....	210
EARTHING CONNECTIONS.....	212
LOW VOLTAGE DEAD WORKING GOLDEN RULES FOR A SAFE ELECTRICAL MAINTENANCE	215



GENERAL

The rod is, in most cases, the most practical, effective and reliable earth connection means.

Highly effective: for a given contact surface area, the linear type electrode provides, both theoretically and practically, the least earth resistance. Furthermore, it enables the most moist and conductive layers to be reached. Easy and quick to install, it requires no earth work. Even inside industrial buildings, it is often possible to install an earth rod exactly where required by breaking through a small area of the floor.

Accessible and testable connection: the use of an inspection box makes it possible to leave the head of the rod and its connection unburied and to periodically test it and measure its resistance.

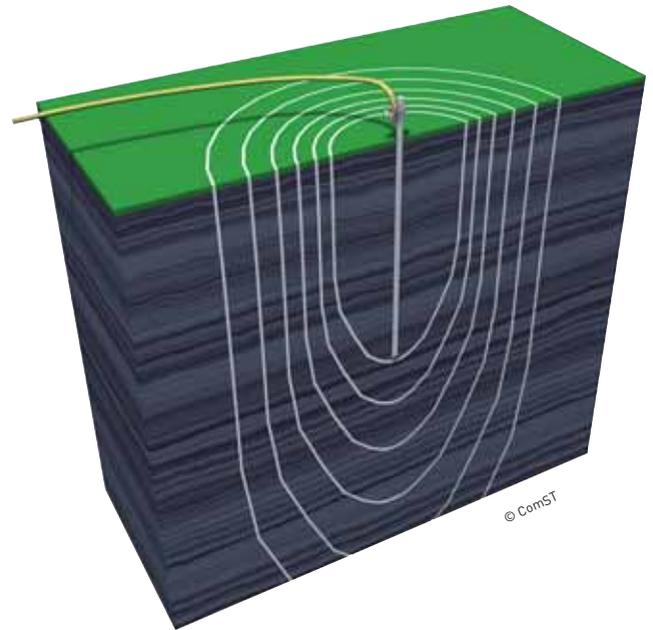

Self connectable rods: The lower end of each rod is equipped with a point used both for driving into the earth and for connection; the upper pierced end receives (without the sleeve) the point of the previous rod. Use a rivetting head so as not to damage the upper end when driving in.

Connectable rods: Conical slide-in provides perfect assembly stability. For deep earth connections.

COPPER/STEEL EARTH RODS

Steel with copper coating by electrolytic process: Minimum Thickness 250 μ (* = 350 μ).

Reference	Type	∅ (mm)	↔	kg	Connection
		Diam.	Lenght (m)	Weight	
CC-10-Y	standard with connector	14.2 unit 16	1	1.2	BCY
CC-15-Y			1.50	1.8	
CC-20-Y			2	2.4	
C2C-10-Z ⁽¹⁾		17.3 unit 19	1	2	C2C-95Z
C2C-15-Z ⁽¹⁾			1.50	2.8	

Self connectable Copper/Steel earth rods

Reference	Type	∅ (mm)	↔	kg	Connection
		Diam.	Lenght (m)	Weight	
A3MC-10-Z*	Self connectable	17.3 unit 19	1	1.8	TO-3-16/19 TO-2-19 C2C-95-Z
A3MC-15-Z*			1.50	2.75	
AC-10-Y	Connectable ⁽¹⁾	14.2 unit 16	1	1.25	TO-3-16/19 TO-2-16 BCY MCY PCY
AC-15-Y			1.50	1.9	
A2C-10-Z*			1	1.95	
A2C-15-Z*			1.50	1.85	

(1) For connectable models, sleeves and tips to be ordered separately.

STAINLESS STEEL EARTH RODS

Strength steel ≥ 90 daN/mm².

Reference	Type	∅ (mm)	↔	kg	Connection
		Diam. (mm)	Lenght (m)	Weight	
AMI-10	Connectable	16	1	1.45	B.CHROM
AMI-15			1.50	2.2	

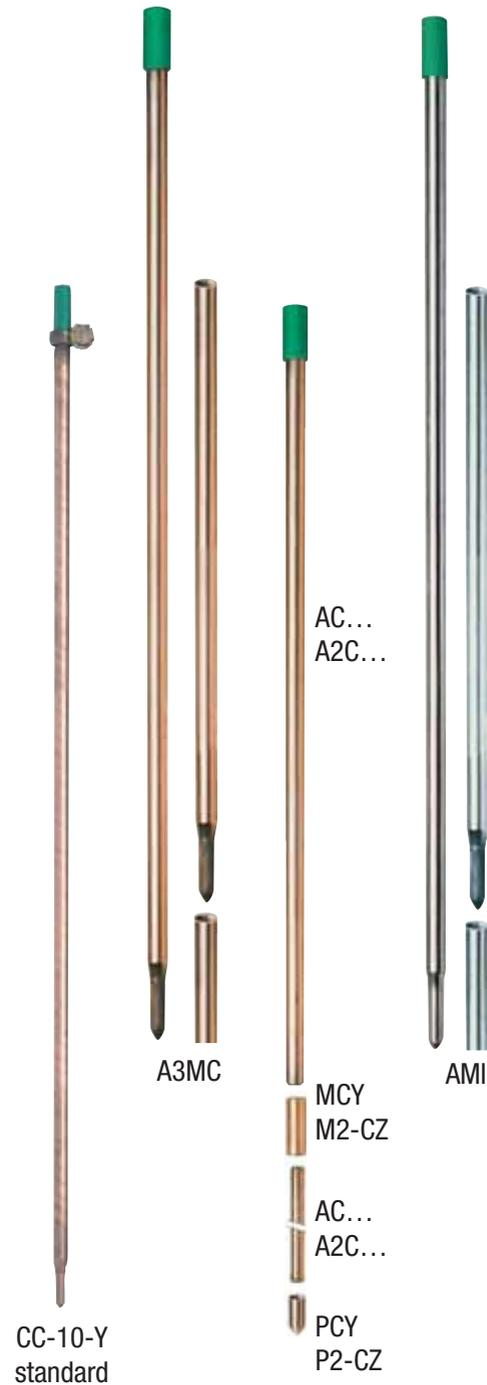

B-CHROM



CONNECTORS

Strength steel ≥ 90 daN/mm².

Reference	∅	Conductors section max	Type section max
	(mm) Diam. Rod	(mm ²)	(mm ²)
TO-2-16	16	40	Copper
TO-2-19	19	40	Copper
TO-3-16/19	19	6 to 95	Copper-aluminium alloy
BCY	14.3	95	Copper-aluminium alloy
C2C95Z	17.3	95	Copper-aluminium alloy



EARTHING CONNECTORS

Interconnects to earth every metallic part of installations.

Reference	Conductors section (mm ²)	→ ← (mm)	
		Clamping capacity	Cond.
COL-8/32	2 cables from 2.5 to 6 mm ²	8 to 32	50
COL-32/100	2 cables from 2.5 to 16 mm ²	32 to 100	50



COL-8/32



COL-32/100

EARTHING CONNECTORS

These earthing connectors allow equipotential connections to be in accordance with NF C-15 100.

They are intended to be placed on cylindrical supports (\varnothing 8 to 32 mm and \varnothing 32 to 100 mm). Stainless steel clamp body and strap. Compact and easy assembly.

2 screws for flat or Phillips screwdrivers :

M4 for COL-8/32 and M6 for COL-32/100.

The screw at the right of the clamp allows to fix the cylindrical support.

The other screw makes it possible to fix the cables derived from equipotentiality (2 cables possible on both sides of the screw, between the clamping plate and the body).

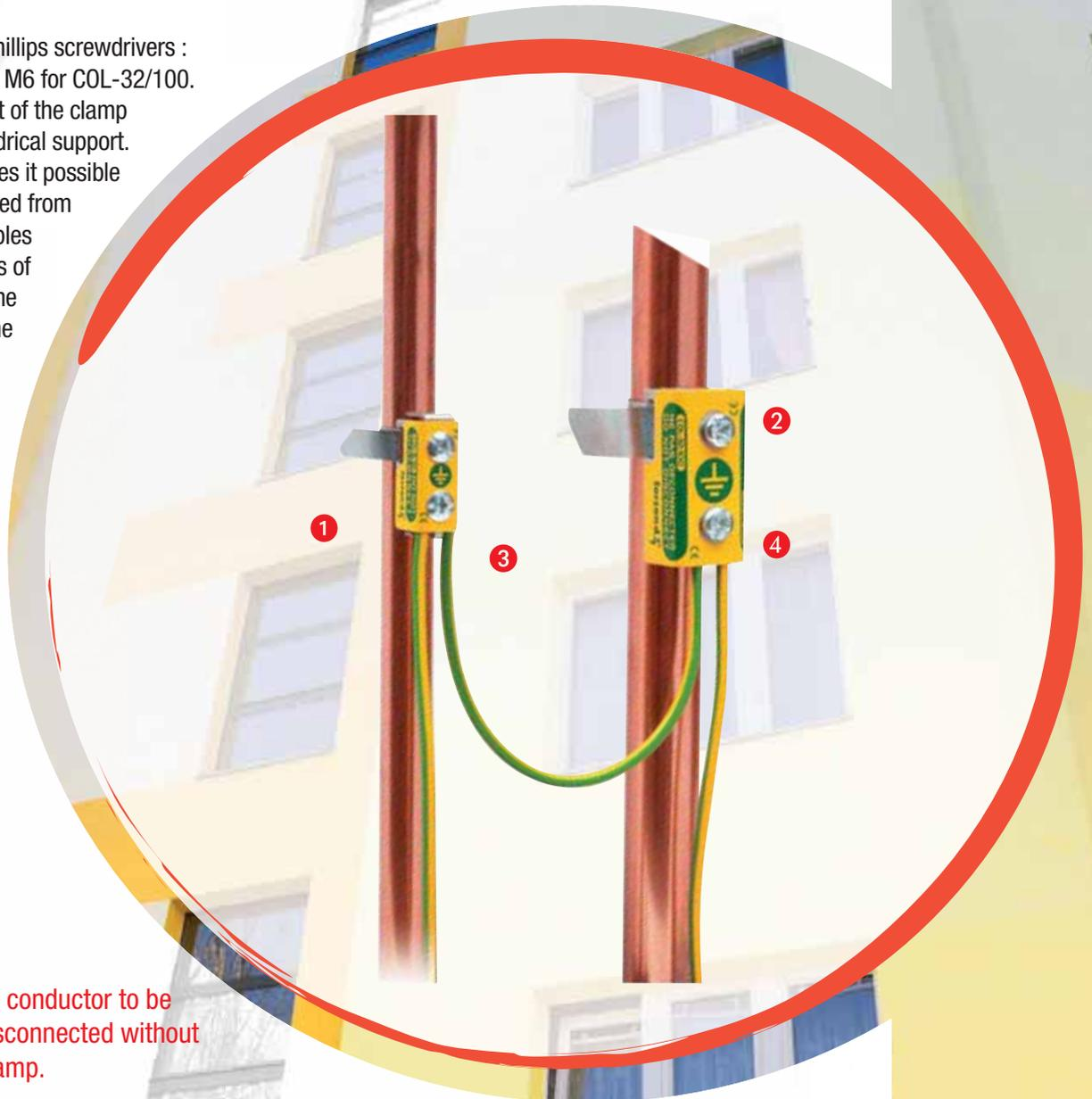

- ❶ Allows the earth conductor to be connected or disconnected without removing the clamp.
- ❷ Caliper / screw system for cable clamping.
- ❸ Compact design and easy to fix in tight spaces (bathroom formwork, ceilings, overmouldings).
- ❹ Immediate visual identification thanks to the “Earth” and text “Do not disconnect” (French and English).

EARTH RESISTANCE TESTER

The MX-430-M allows the measurement of earth resistance and earth specific resistivity and also the parasite voltages caused by grounding parasitic voltage presence.

This equipment is suitable for fast and easy measurement of the grounding resistance in home, industrial buildings, substations,...

Technical features

- Application: measurement of grounding resistances (with 3 earth rods), earth resistivity (with 4 earth rods) and parasite voltage presence.
- Range of measurement: 0 - 20 Ω ; 0-200 Ω ; 0-2000 Ω and 20 KΩ.
- Voltmeter: voltmeter function in AC range as a conventional voltmeter 0-200 V AC.
- Operation frequency: 1470 Hz.
- Current in and out put power: less than 0,5 W and the output current is limited to less than 15 mA (peak to peak).
- Operation temperature: -10°C / +50°C.
- Storage temperature: -25°C / +65°C.
- Humidity: 95% RH (without condemnation).

Reference	 (mm)	 kg
	Dimensions (mm)	Weight
MX-430-M	221 x 189 x 99	2

BENEFITS

- High visibility 3 1/2 digit display with direct readings, even under sunlight.
- Connexion wire including a 12 V car battery.
- Rechargeable internal battery managed by a microprocessor which modulates the load current as per the status of the battery, thus increasing battery life and the service life of the device.

ACCESSORIES (MEASUREMENT KIT)

- 1 storage bag.
- 4 earth rod copper plated steel.
- 1 x 5 meter black cable.
- 1 x 40 meter red cable.
- 2 x 20 meter cable (1 blue and 1 green).
- 1 x 5 meter green cable to connect to the grounding system.
- 1 hammer.
- 1 reel tape measure 50 m.

Reference	Conductors section (mm ²)	 kg
		Weight
MX-433-T	570 x 220 x 160	7.7





The new website www.catuelec.com is online!

- Responsive site, which adapts to all screen sizes (smartphone, tablet, computer)
- Improved and structured design with complete content on solutions:
 - technical sheet,
 - videos,
 - leaflets,
 - user manual,
 - authorization for use,
 - associated products,
 - commercial documentation
- Highlighting news and the latest CATU innovations

FOLLOW

CATU™ NEWS



FOLLOW US AS WELL ON YOUTUBE
AND SUSCRIBE TO OUR CHANNEL.

NUMEROUS VIDEOS ON CATU'S
SOLUTIONS IN ELECTRICAL SAFETY !

AVAILABLE IN DIFFERENT LANGUAGES.



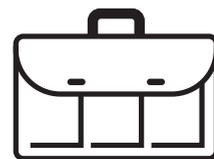

ELECTRICIAN BAGS





ELECTRICIAN BAGS

SMALL SOFT BAG

Textile small size bag.

Reference	 (mm)	 kg
	Dimensions	Weight
MO-103	300 x 180 x 70	0.6
MO-43	280 x 200 x 90	0.3

BENEFITS

- MO-43: Numerous pockets (fix or removable) for a great storage modularity. Adjustable carrying strap with shoulder pad foamed.
- MO-103: Quick inside visualisation thanks to the transparent cover.



RIGID BAG

Textile bag - foamed structure.

M-87370: with loop for attachment to rolling bag. Rigid plastic abrasion-resistant bottom.

MO-37: with handles.

Reference	 (mm)	 kg
	Dimensions	Weight
M-87370	440 x 330 x 160	1.1
MO-37	400 x 310 x 250	0.6



HARD BOTTOM BAG

Textile bag.

Reference	 (mm)	 kg
	Dimensions	Weight
MO-42/1	320 x 240 x 170	0.7
MO-42/2	400 x 270 x 220	0.8

BENEFITS

- Metal wire framing structure, allowing an immediate access to the bag content.
- Rigid plastic abrasion-resistant bottom and ensuring great stability of the bag in the open position.



LARGE SOFT BAG

Textile bag. Lockable with padlock (not included).

Reference	(mm)	kg
	Dimensions	Weight
MO-50	Ø 250 x L 620	0.5
M-87386	650 x 150 x 250	0.9
M-87387	690 x 300 x 140	0.6
M-87295	550 x 300 x 300	1.5



MO-50



M-87386



M-87387



M-87295

BENEFITS

- MO-50: lightweight bag suitable for carrying PPE and insulating mats 600 mm wide.
- M-87386 and M-87387: multi-pocket bags for electrician equipment. Suitable to protect insulating mats 600 mm wide.
- M-87295: very resistant bag suitable for PPE or earthing equipment.

TOOLS BAGS

M-87303: textile flat tools case.

MO-39: textile tools box.

MO-34: leather tools bag.

MO-36: leather tools bag.

Reference	(mm)	kg
	Dimensions	Weight
M-87303	400 x 350 x 40	0.5
MO-39	480 x 320 x 230	0.9
MO-34	410 x 280 x 150	3.2
MO-36	450 x 250 x 200	4.8



M-87303



MO-39



MO-36



MO-34





ELECTRICIAN BAGS

BACKPACK

Ergonomic backpack with foam structure which provides maximum comfort to end user and protection for tools.

Reference	 (mm)	 kg
	Dimensions	Weight
MO-38	400 x 330 x 180	0.6

BENEFITS

- Reversible tool tray with handle for easy carriage.
- Velcro strap for attachment of the insulating mat.



MO-38

WHEELED BACKPACK

Ergonomic wheeled backpack, reducing musculoskeletal disorders. Perfectly fitted for transport and storage of the tool kits, laptop, insulating mat and helmet. Provides 3 modes of use: hand, wheels or back.

Reference	 (mm)	 kg	Capacity (L)
	Dimensions	Weight	
MO-44	460 x 300 x 240	3.2	30



MO-44



CUSTOMIZATION

CATU can create a unique bag with your logo.
Minimum order:
10 pieces.



Self gripping straps,
see PAGE 34



Insulating sticks bag,
see PAGE 189



FOCUS

EX
PERT

WHEELED BACKPACK

This ergonomic wheeled backpack is perfectly fitted for transport and storage of tools kits, laptop, insulating mat and helmet. Provides 3 modes of use: hand, wheels or back.

Its ultra-resistant and light structure provides a great stability. It's equipped with ergonomic foamed shoulder straps, with possibility to store them in a special pocket for not dragging on the ground, but also foam-filled protection reinforcements for a better back and lumbar comfort.



- 1 Telescopic adjustable handle 2 heights.
- 2 Numerous interior and exterior pockets for a great storage capacity and removable tool-holder. Zip closure with double metal slider lockable to secure the content.
- 3 Name-tag label for luggage recognition and reflective strip for night-time visibility.

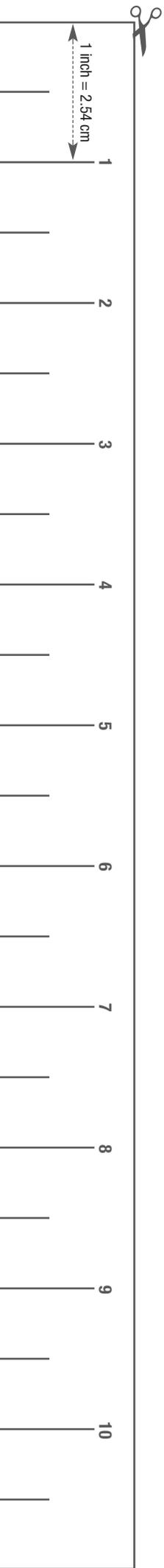

CHOOSE YOUR GLOVES SIZE!



1 Stretch out your hand.

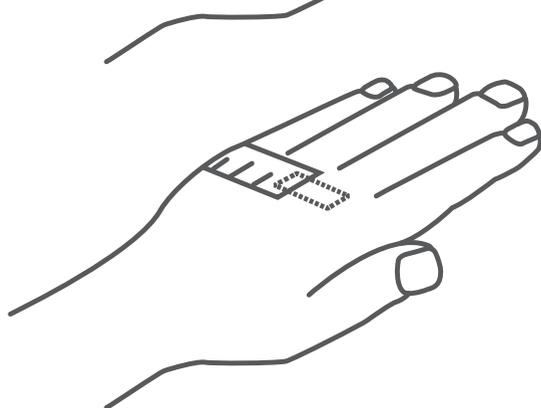

2 Wind the tape measure around your hand at the level of your knuckles. You can position the tape easier by taping it on the top of your hand.

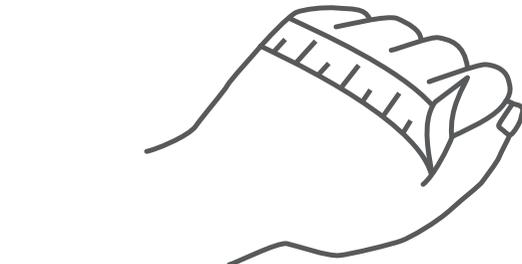

3 Slightly fold your hand without clenching your fist and take the measurement. If you are between two sizes, take the biggest one.

WOMEN GLOVES SIZE

Inch	6	6 ^{1/2}	7	7 ^{1/2}	8
cm	15.2	16.5	17.8	19	20.3
Sport size	XS	S	M	L	XL

MEN GLOVES SIZE

Inch	7 ^{1/2}	8	8 ^{1/2}	9	9 ^{1/2}	10	10 ^{1/2}	11	12
En cm	19	20.3	21.6	22.9	24.1	25.4	26.7	28.0	30.5
Sport size	XS	S	M	L	XL	XL	XXL	XXL	

Print this page and cut out the ruler.
Ensure that the tape measures **ten inches**
or **27.90 cm** once printed
(scale of your printer = 100%).

IMPORTANT

In the window of the printer's settings,
check that the "scaling" drop-down
menu is set to: "none".

CHOOSE YOUR HARNESS SIZE!

HARNESS SIZE BOARD (in cm)

Reference	Chest (A)	Size (B)	Thigh (C)	Height (D)
S	70 - 100	75 - 100	50 - 70	60 - 75
M	80 - 120	90 - 120	55 - 75	75 - 85
XL	100 - 150	100 - 135	55 - 90	80 - 95

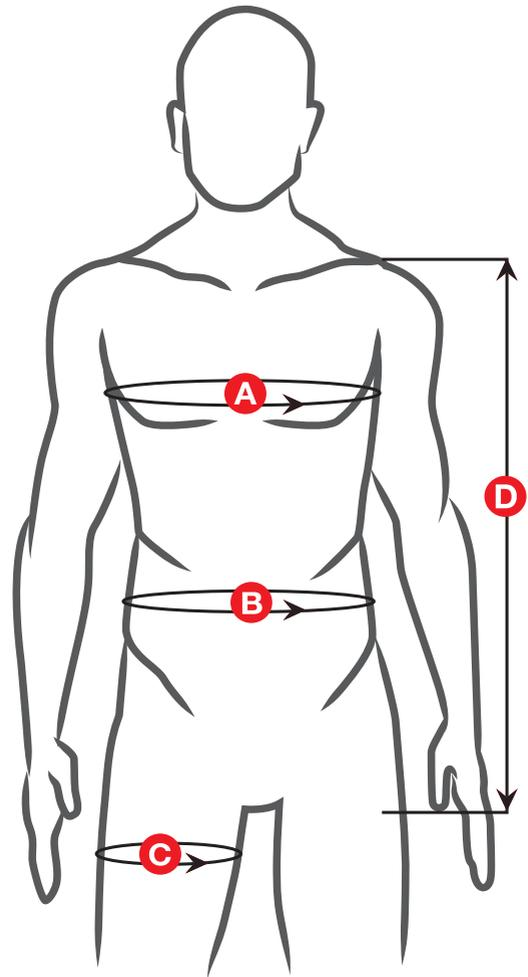

CHOOSE THE SIZE OF YOUR CAT'ARC CLOTHING!

JACKET AND SWITCHING JACKET (in cm)

Size to order	XS	S	M	L	XL	2XL	3XL	4XL	5XL
A - Maximum chest measurement	90	94	98	101	105	109	113	117	121
C - Maximum hip measurement	92	94	98	102	106	110	113	117	121

The chest measurement defines the size of the garment as long as the hip measurement is less than or equal to the measurement shown in the table.
If not, choose the next size up.

TROUSERS (in cm)

Size to order	XS	S	M	L	XL	2XL	3XL	4XL	5XL
C - Maximum hip measurement	90	94	98	102	106	110	113	117	121

COVERALL (in cm)

Size to order	XS	S	M	L	XL	2XL	3XL	4XL	5XL
A - Maximum chest measurement	90	94	98	101	105	109	113	117	121
B - Maximum waist measurement	92	96	100	104	108	111	115	119	123
C - Maximum hip measurement	102	106	110	113	117	121	125	129	133

The chest measurement defines the size of the garment as long as the waist measurement and the hip measurement are less than or equal to the measurements shown in the table. If not, choose the next size up.

LOW VOLTAGE DEAD WORKING GOLDEN RULES FOR A SAFE ELECTRICAL MAINTENANCE

FIRST ANALYSE ELECTRICAL RISKS AND SELECT CATU EQUIPMENT TO ENSURE YOUR PROTECTION AND SAFETY.



MO-286



CGM SERIES



AM-467-6B



MS-917-L



AL-201/1



AL-230-Z-EX



MC-296-NFC

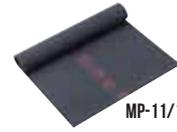

MP-11/16



AL-31/05



AL-316

1 SEPARATE THE WORK AREA FROM ALL SOURCES OF POWER SUPPLY.



© ComST

2 LOCK THE CIRCUIT BREAKER IN THE OPEN POSITION AND TAG OUT.



© ComST

3 NETWORK IDENTIFICATION.



© ComST

4 CHECK THE ABSENCE OF VOLTAGE.



© ComST

5 APPLY AN APPROPRIATE SHORT-CIRCUITING AND EARTHING SYSTEM.



© ComST

PROTECT THE WORK AREA FROM THE CLOSE LIVE PARTS.



© ComST



Handwritten notes area consisting of 20 horizontal dotted lines.



After Sales Services

xavier.lebec@catuelec.com

Phone: +33 (0)1 42 31 46 85

latif.ozmen@catuelec.com

Phone: +33 (0)1 42 31 46 86

Technical Assistance

corinne.peigne@catuelec.com

Phone: +33 (0)1 42 31 46 24

charles.saulnier@catuelec.com

Phone: +33 (0)1 42 31 63 10

The characteristics and technical informations stated in our literature are only for your guidance and therefore cannot be considered as contractual.
our company is entitled to modify at any time the characteristics of its equipment.

In case of modification of these characteristics, our company would not be obliged to supply materials conform to those previously in force.

"alu-Metal, alu-Script, Catex, Catohm, Catu, Catumètre, Clipblock, Detex, Detex-lumifix,
Identex, Isomil, Isostop, normafix, Pointest, Piezo-test, Pelican 2, triplex" are trade marks of CATU SAS.



© 2020 CATU SAS BAGNEUX

All reproduction, adaptation and translation rights reserved for all countries.



Distributed by:



10, avenue Jean-Jaurès – 92 222 Bagneux, France
Phone: +33 (0)1 42 31 46 00 - Fax : +33 (0)1 42 31 46 32
Phone business: +33 (0)1 42 31 46 08

www.catuelec.com

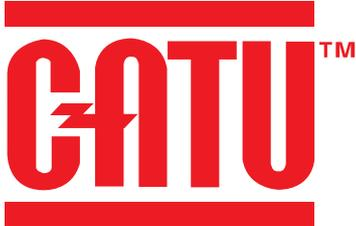

SICAME GROUP